

MPC MILITARY FIELD-GRADE

MILITARY POWER CONDITIONER

Operator's Guide MPC-1500 Series



Made in USA

MPC-1500-1S



*N+M Redundancy
(optional)*



MPC-1500-1U

SynQor[®]

Advancing The Power Curve[®]

Table of Contents

SECTION I

WARNINGS

<i>Hazardous Voltages</i>	4
<i>Hazardous Energies</i>	5
<i>Protection from the Environment</i>	5
<i>No User Serviceable Parts</i>	5

SECTION II

GENERAL PRODUCT INFORMATION

<i>Product Description</i>	6
<i>Product Topology</i>	7
<i>Part Numbering Scheme and Options</i>	9
<i>Electrical Characteristics</i>	11
<i>1U Mechanical Diagram</i>	12
<i>MPC Efficiency</i>	13
<i>Total Output Power that can be derived from the AC INPUT</i>	13
<i>Power Cable Wiring Diagram</i>	16
<i>Power Cable Wire Size</i>	17

SECTION III

OPERATION

<i>Set-Up</i>	18
<i>Start-Up</i>	18
<i>Shut-Down</i>	18
<i>Power Cable Connections/Disconnections While Operating</i>	19
<i>Cooling System</i>	20
<i>Front Panel Indicators</i>	21
<i>LEDs</i>	21
<i>Audible alarm</i>	23
<i>Operating Environment</i>	24

Visit our website for
more information



SECTION IV

MULTIPLE UNIT CONFIGURATIONS

<i>General Considerations</i>	25
<i>Standard Paralleling -F Option</i>	26
<i>Expanded Paralleling -R Option</i>	27
<i>Parallel Configurations of the AC OUTPUTS: Up to Three Units</i>	28
<i>Multi-unit Configurations</i>	28
<i>Parallel Connection of the AC OUTPUTS</i>	29
<i>Two MPC units with AC OUTPUTS Paralleled</i>	29
<i>Three MPC units with AC OUTPUTS Paralleled</i>	30
<i>Series Split Phase Connection of AC OUTPUTS</i>	31
<i>3-Phase Connection of AC OUTPUTS</i>	32
<i>Parallel Configurations of the AC OUTPUTS: Up to 32 Unit -R option</i>	33
<i>Parallel Connection of DC OUTPUTS</i>	34
<i>Connection of the AC and/or DC INPUTS</i>	34
<i>3-Phase AC INPUT Source</i>	34
<i>Multi-unit AC Output On/Off Control – Standard Parallel (-F option)</i>	35
<i>Multi-unit AC Output On/Off Control – Expanded Parallel (-R option)</i>	35
<i>AC Output Neutral Grounding</i>	35
<i>Wiring Caution</i>	36

SECTION V

CONTROL INTERFACE DETAILS

<i>Control Cable Connections</i>	37
<i>Internal User I/O Circuits</i>	38
<i>Remote On/Off Switch Connections</i>	38
<i>Digital Input/Output Control Signals</i>	39
<i>RS232 Serial Interface</i>	39
<i>Ethernet Interface</i>	40

SECTION VI

MAINTENANCE

<i>Fans</i>	41
<i>Cleaning</i>	41

SECTION VII

TROUBLE-SHOOTING GUIDE

<i>Fault Conditions</i>	42
-------------------------------	----

Hazardous Voltages

The **INPUT AND OUTPUT POWER** connectors and cables of the SynQor MPC may have voltages that are unsafe. **INJURY OR DEATH ON CONTACT** may result. Appropriate safety precautions should be taken. All connections should be made in accordance with **LOCAL ELECTRICAL CODES**.

- The MPC **CHASSIS** should be connected to earth or system ground with Ground Stud on the rear panel, see mechanical diagrams.
- For the **AC INPUT** cable and connector:
 - Do not assume that a hazardous voltage is not present at the terminals of the AC input connector, even if the MPC appears to be off.
 - Do not make contact with the terminals of the AC input connector.
 - Always connect the cable to the MPC before it is connected to the source of AC power.
 - Always disconnect the AC input cable from the source of AC power before disconnecting it from the MPC.
 - If the AC input cable is connected to the source of AC power and not connected to the MPC, do not contact the exposed terminals of the AC input cable.
 - Do not assume that the source of AC power is not present.
 - Connections between the AC input cable and the source of AC power should not be accessible.
- For the **AC OUTPUT** cable and connector:
 - Do not assume that a hazardous voltage is not present at the terminals of the AC output connector, even if the MPC appears to be off.
 - Do not make contact with the terminals of the AC output connector.
 - Connect the AC output cable to the MPC before the MPC is turned on.
 - If connection of the load to the AC output cable has exposed conductors, make this connection before connecting the AC output cable to the MPC.
 - Connections between the AC output cable and the load should not be accessible.
- For the **DC INPUT** cable and connector (if present):
 - The rated DC input voltage of the MPC is below the level considered hazardous.
 - The DC input terminals of the MPC are isolated from the AC input and AC outputs with reinforced safety insulation.
 - However, never assume the terminals of the DC input connector or the wires of the DC input cable are safe to contact, *even if the MPC or DC input source appears to be off*.

- For the **DC OUTPUT** cable and connector (if present):
 - The rated DC output voltage of the MPC is below the level considered hazardous.
 - The DC output terminals of the MPC are isolated from the AC input and AC outputs with reinforced safety insulation.
 - However, never assume the terminals of the DC output connector or the wires of the DC output cable are safe to contact, even if the MPC appears to be off.

Hazardous Energies

The **INPUT AND OUTPUT POWER** connectors and cables of the SynQor MPC may be the source of high levels of energy. Do not inappropriately make electrical contact between any terminal of a connector and another, or between any wire of a cable and another, or between any terminal or wire and the MPC's chassis or ground. **DAMAGING ELECTRICAL ARCS** may result. Care should be taken to avoid accidental electrical contacts of this sort.

Protection from the Environment

The SynQor MPC is a ruggedly built product having its electronics contained in sealed chambers. It is capable of withstanding harsh levels of mechanical acceleration, shock and vibration, temperature and pressure variations, and exposure to water, salt, sand and dust within the levels specified in the data sheet. **THESE LEVELS SHOULD NOT BE EXCEEDED.**

Do not obstruct the air intake in the front of the MPC or the fan exhausts in the rear panel of the MPC while the MPC is operating.

No User Serviceable Parts

The SynQor MPC has no user serviceable parts inside of it. **DO NOT REMOVE** the cover of the MPC or any of its connectors. Only factory trained personnel should perform repairs.

Product Description

The SynQor MPC-1500 Series is an advanced technology military-grade Power Conditioner (MPC) that uses highly efficient power electronic circuitry to achieve a high power level in a low-profile, low-weight, rack-mountable package. It provides voltage and frequency conditioning, electrical isolation, and power flow smoothing between the power inputs and its power outputs.

A communication/control port is available to permit monitoring and control by a host computer system. Front panel LEDs and an audible alarm provide information on the status of the MPC.

The MPC-1500 Series products can draw power from an AC input having a wide range of voltage and frequency levels, or from an optional 28 V nominal DC input. The AC input has priority over the DC input. The MPC provides up to 1500 VA and 1250 W of AC output power at 115 Vac. The pure sine wave AC output voltage can drive any non-linear load with a crest factor up to 2.5, and any load power factor from 0.0 to 1.0. There are two optional DC outputs at various voltage and power levels available. Please note: The total AC plus DC output power is limited to 1250 W.

The electronic circuitry within the MPC-1500 Series products is designed, qualified and screened according to SynQor's MIL-COTS Standards. It complies with the requirements of MIL-STD-704F, MIL-STD-1399-300B, MIL-STD-1275D and MIL-STD-461F, as well as IEC-EN61000 specifications for world-wide commercial utility applications.

The MPC-1500 Series products are designed and manufactured to withstand the harsh environments and use encountered in military applications. The electronic circuitry is contained in a sealed chamber constructed from a die-cast aluminum chassis that is weather-proof and shock-proof. Redundant, water-proof fans on the rear panel draw cooling air over the heat-sink fins below the sealed chamber. Military-grade circular connectors are used, and optional attached connector covers are available for when the cables are not attached. The MPC-1500 Series products comply with a wide range of testing according to MIL-STD-810G.

The MPC-1500 Series is a 1U high unit that comes in two form factors. The MPC-1500-1U form factor is 21.6" deep, and weighs 24 lbs. The MPC-1500-1S "Shallow Rack" form factor is 14.8" deep, and weighs 22 lbs. Both form factors have identical electrical performance. The SynQor MPC-1500 Series products are designed and manufactured in the U.S.A..

Product Topology

The SynQor MPC-1500 Series products use a true on-line double conversion topology that provides protection to the load from spikes, noise, surges, brownouts, blackouts, etc. in the input power sources. They also provide smoothing of load transients and nonlinear load profiles so that the input power sources are not subjected to these disturbances. There is a seamless transfer from any power source to another so that there is no disruption in the output voltage waveform.

As the figure below shows, there is a nominal 28 V mid-bus within the MPC that draws power from one of up to two power sources: the AC INPUT, or the optional DC INPUT (with that order of priority based on availability). EMI filters are present at all external inputs and outputs.

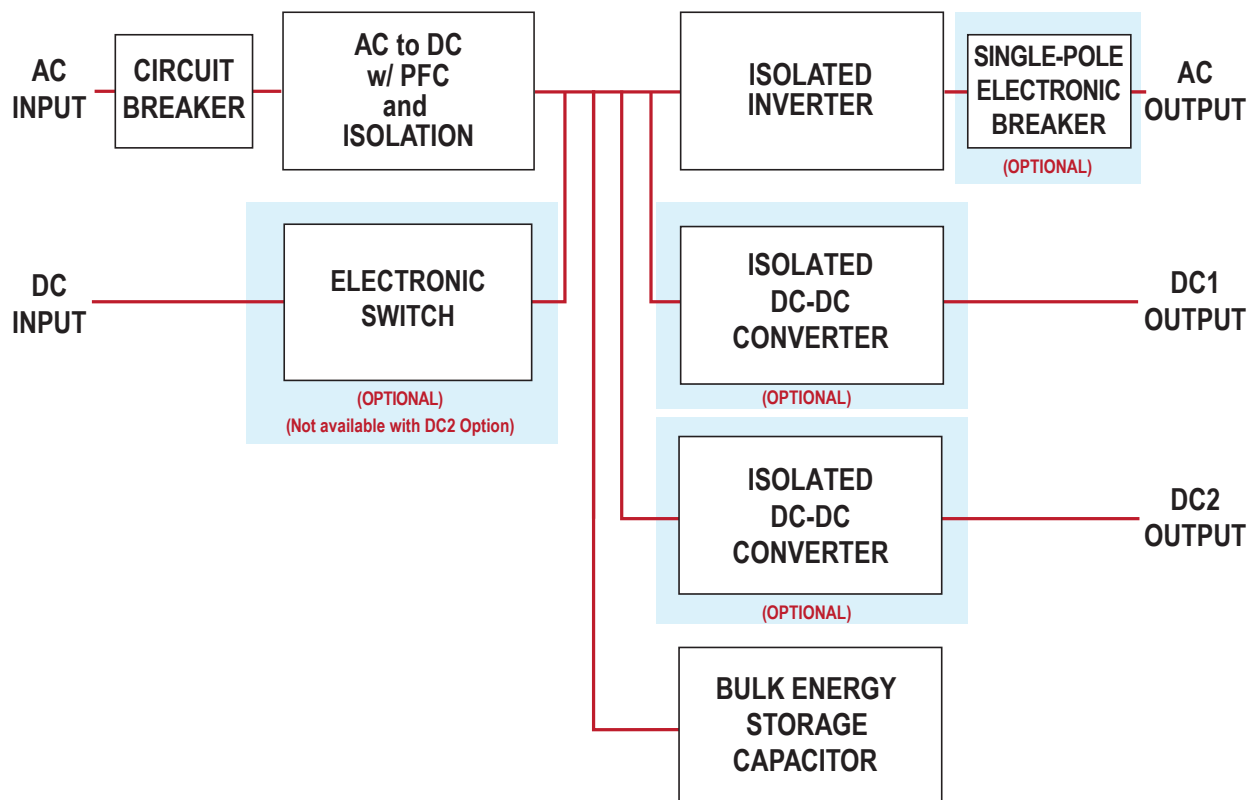

Power flows from the AC INPUT through an AC-DC converter that has Power Factor Correction (PFC) and high-frequency safety isolation. Power flows from the DC INPUT through an electronic switch that is closed when the AC INPUT power is absent and the DC INPUT voltage is within its specified range.

The AC OUTPUT is created by an inverter that draws power from the mid-bus. This inverter provides high frequency safety isolation and a pure-sinusoidal output voltage waveform. An optional electronic breaker can be added to the AC output. This one pole hot side only electronic breaker allows for fault tolerant, glitch free operation when several MPC units are placed in parallel.

There are two optional DC outputs available. The DC1 option is limited to 500 W. The DC2 option can deliver up to 1250 W output. When the DC2 option is selected, DC Input is not available. The DC1 and DC2 outputs are isolated from each other and the AC output.

Bulk energy storage capacitors are connected to the mid-bus to help smooth imbalances in power flow between the inputs and outputs of the MPC.

There is a communication/control port that provides a digital interface to a host computer system.



MPC in Transit Case Option

Part Numbering Scheme and Options

This table shows the part numbering scheme for the full line of SynQor MPC products:

Base Model			
Model Number	Power	Height (W x D x H)	Weight
MPC-1500-1S	1250 W 1500 VA	1U (17.00" x 14.80" x 1.73")	22 lbs.
MPC-1500-1U	1250 W 1500 VA	1U (17.00" x 21.60" x 1.73")	24 lbs.

Base Model	Options							Additional Options	
	AC Input Freq	AC Output Voltage	AC Output Neutral Wire	AC Output Set Point Freq	DC Input / DC2 Output	DC1 Output			
MPC-1500-1U MPC-1500-1S	L W	1 2	G F R	5 6 4	S D M P R V W	00 12 15 24 28 40 50		-E	00 CE

Not all combinations make valid part numbers, please contact SynQor for availability. See the Product Summary web page for more options.

***Notes:**

Order **"F"**: Floating" option when configuring the AC output for multi-unit combinations of up to 3 units.

Order **"R"**: AC Output Electronic Breaker" option for fault-tolerant, glitch-free parallel systems of up to 32 units with N+M redundancy. The AC output neutral wire will not be connected to the chassis.

Examples:

MPC-1500-1U-L1G6D28-ECE,
MPC-1500-1S-L1F4S00-E00

Options	
AC Input Freq	L 47-65 Hz W 47-800 Hz
AC Output Voltage	1 115 Vrms 2 230 Vrms
AC Output Neutral Wire	G Grounded F Floating* R AC Output Electronic Breaker*
AC Output Set Point Freq	5 50 Hz 6 60 Hz 4 400 Hz
DC Input / DC2 Output	S Not Installed D DC Input M DC2 Out 24 VDC with Droop Share P DC2 Out 24 VDC No Share R DC2 Out 28 VDC with Droop Share V DC2 Out 28 VDC No Share W DC2 Out 50 VDC No Share
DC1 Output	00 None 12 12 V 15 15 V 24 24 V 28 28 V 40 40 V 50 50 V
Additional Options	-E Ethernet/SNMP with Configuration Loading 00 No CE Marking CE CE Marking

The MPC-1500 Series of products provide up to 1500 VA and 1250 W of total output power (AC plus DC), in the following physical format:

- 1U height. 22 lb. or 24 lb. weight, 14.8" or 21.6" depth respectively.

Various options can be specified according to the part numbering scheme shown in the table:

- The allowable frequency of the AC INPUT can either be in the 47-65 Hz range (for 50 Hz and / or 60 Hz systems) or Wide-range in the 47-800 Hz range (for 400 Hz and Variable Frequency systems).
- The output voltage of the MPC-1500 Series can be 115 Vrms or 230 Vrms.
- The AC output can be configured with its neutral wire internally grounded to the chassis of the MPC or left floating for shipboard applications.
- The Electronic Breaker option adds fault tolerant, glitch free operation multi-unit for N+1 or N+M redundancy. This option also allows up to 32 unites total in Single Phase, Split Phase or 3-Phase system.

- The initial set-point frequency of the AC OUTPUT voltage can be 50 Hz, 60 Hz or 400 Hz. Regardless of the initial set-point frequency, the actual frequency can be set through the communications/control port.
- There is an optional DC INPUT that is specified to comply with MIL-STD-704F and MIL-STD-1275D for 28 V systems.
- Two optional DC OUTPUT capabilities are available: DC1 with up to 500 W capability, and DC2 with up to 1250 W capability an optional droop share.

The following pages show the electrical and mechanical specifications of the MPC-1500-1U high product. The data sheet showing these specifications and other information can be found at the web site www.synqor.com/MPC.

MPC-1500-1U & MPC-1500-1S

Front Panel



Rear Panel

MPC Units with DC Input / DC1 Output Options

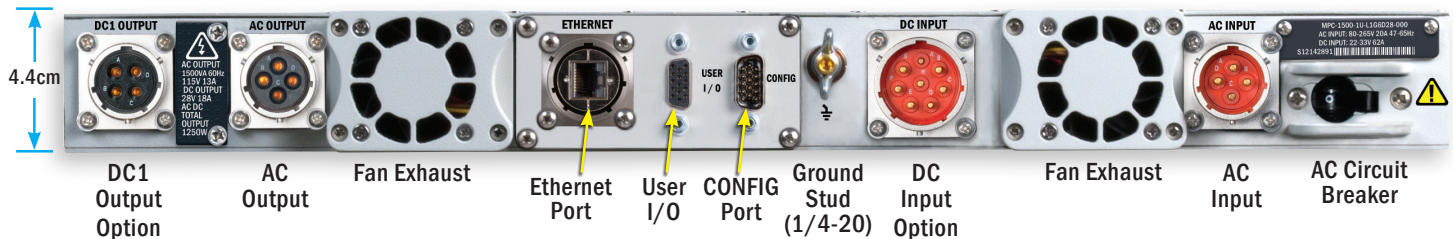

Rear Panel

MPC Units with DC1 Output / DC2 Output Options

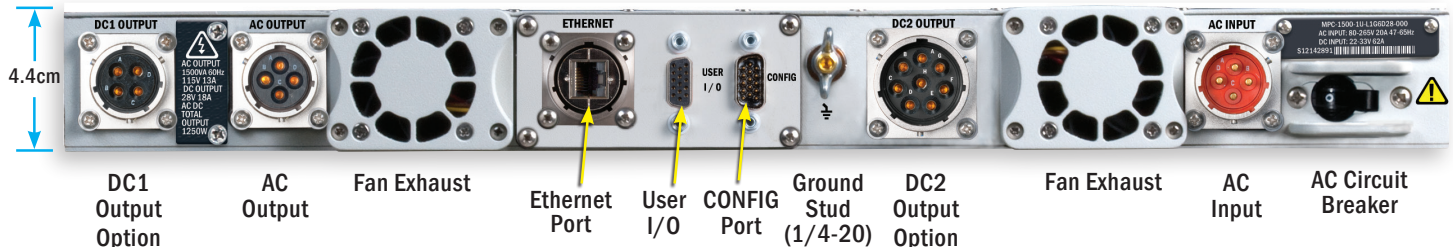

Electrical Characteristics

INPUT CHARACTERISTICS

Operating AC Input

Voltage	80-265 Vrms*
Frequency	47-65 Hz (47-800 Hz Optional)
Input Power Factor	>0.98 at 47-65 Hz >0.97 at 400 Hz >0.93 at 800 Hz
Maximum Input Current Continuous	20 A (full load, 85 Vrms)
AC Input Circuit Breaker Rating (* Power Derating to 80% below 90 Vrms)	25 A

Operating DC Input (Optional)

Voltage	22-33 V
Continuous Maximum Input Current	62 A (full load, 22 V)
Transient Maximum Input Current	75 A

OUTPUT CHARACTERISTICS

Total Output Power Continuous	1250 W (1500 VA)
Maximum DC1 Output Power	510 W
Maximum DC2 Output Power	1250 W
(Note: Available AC power is reduced by power delivered to the DC output)	

AC Output

AC Output Waveform	Pure Sinusoidal
Voltage	115 Vrms \pm 3% 230 Vrms \pm 3%
Frequency	60 Hz \pm 0.5% 50 Hz \pm 0.5% 400 Hz \pm 0.5%
Peak Load Current	26 A (115 Vrms) 13 A (230 Vrms)
Load Power Factor	0-1.0 (leading or lagging)
Total Harmonic Distortion	2% (1000W resistive load)

DC1 Output (optional)

Voltage Regulation (Over Load & Temperature)	\pm 3%
Common Voltage/Power combinations (DC1) (Other Options Available)	12 V at 42 A =504 W 15 V at 34 A =510 W 24 V at 21 A =504 W 28 V at 18 A =504 W 40 V at 12.5 A =500 W 50 V at 10 A =500 W

DC2 Output (optional)

Voltage Setpoint	\pm 3%
------------------	----------

No Sharing

Voltage Regulation (Over Load & Temperature)	-2%
Common Voltage/Power combinations (DC2)	24 V at 50 A =1200 W 28 V at 44.6 A =1250 W

Droop Share (Output droops vs. load to allow passive sharing among modules.)

24 V Option

Voltage Regulation (Over Load & Temperature)	-15%
	26 V at 0 A 22 V at 50 A =1100 W

28 V Option

Voltage Regulation (Over Load & Temperature)	-13%
	30 V at 0 A 26 V at 48.1 A =1250 W

ENVIRONMENTAL CHARACTERISTICS MIL-STD-810G

Temperature Methods 501.5, 502.5

Operating Temperature	-40 °C to +55 °C
Non-operating Temperature	-40 °C to +65 °C

Temperature Methods 503.5

Storage Temperature	-40°C — +70°C
---------------------	---------------

Altitude Method 500.5

Operating	0 - 18,000 ft
Non-operating Temperature	0 - 40,000 ft

Environmental Tests

Shock/Drop	Method 516.6, Procedures 1,4,6
Temperature Shock	Method 503.5, Procedure 1
Vibration	Method 514.6, CAT 5, 7, 8, 9, 24
Fungus	Method 508.6
Salt Fog	Method 509.5
Sand and Dust	Method 510.5, Procedures 1,2
Rain	Method 506.5 Procedure 1
Humidity	Method 507.5 Procedure 2
Mechanical Vibrations of Shipboard Equipment	Method 528 Procedure 1

RELIABILITY CHARACTERISTICS MIL-HDBK-217F

MTBF	100 kHrs	MIL-217F Ground Benign, Ta=25 °C
------	----------	----------------------------------

ELECTROMAGNETIC CAPABILITY MIL-STD-461F

CE101	30 Hz - 10 kHz
CE102	10 kHz - 10 MHz
CS101	30 Hz - 150 kHz
CS106	10 kHz - 40 GHz
CS114	10 kHz - 200 MHz
CS116	10 kHz - 100 MHz
RE101	30 Hz - 100 kHz
RE102	10 kHz - 18 GHz
RS101	30 Hz - 100 kHz
RS103	2 MHz - 40 GHz

MECHANICAL CHARACTERISTICS

1U Standard Chassis

Chassis Size	17.00"W x 21.60"D x 1.73"(1U)H
Case Material	Aluminum
Total Weight	24 lbs.

Connectors

AC Input Connector	MS3470L14-4P
User I/O Ports	HD DB15 Female
Configuration I/O Port	HD DB15 Male
Ethernet Port	Amphenol RJF22N00, Code B
DC Input Connector	MS3470L18-8P
AC Output Connector	MS3470L14-4S
DC1 Output Connector	MS3470L14-4SW
DC2 Output Connector	MS3470L18-8S

Cooling Exhaust Fans

Sound Pressure Level (SPL)	54 dB(A)
Air Flow	0.67(m ³ /min) 23.7 CFM

Two fans in system, above specs are for each fan separately.

1U Mechanical Diagram

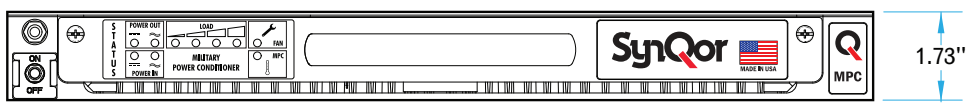
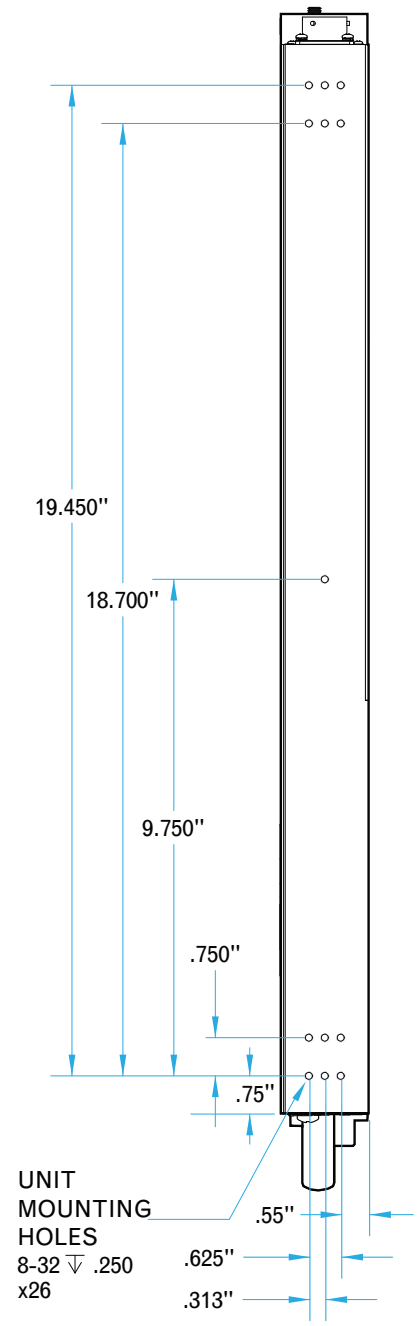
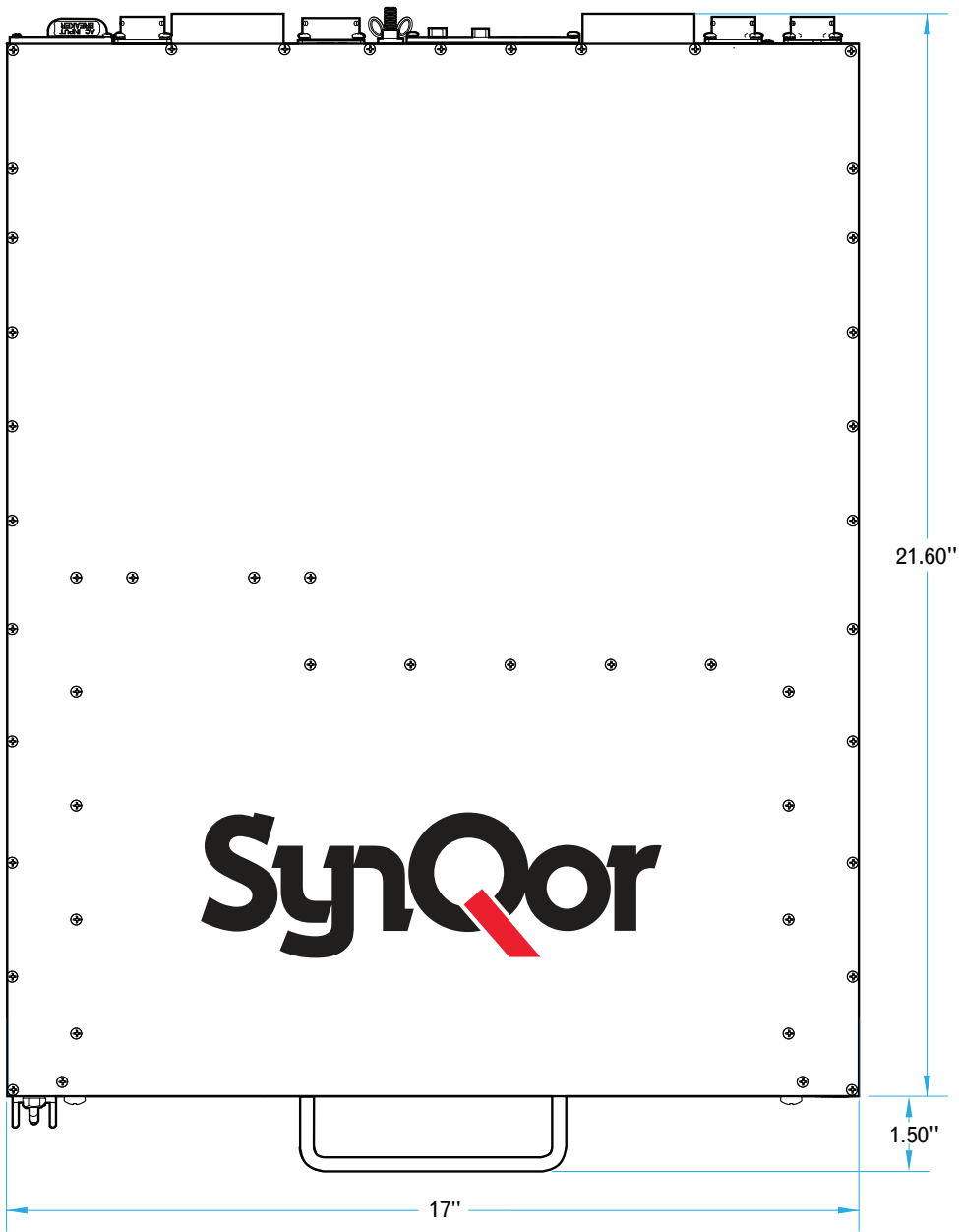

1S Mechanical Diagram

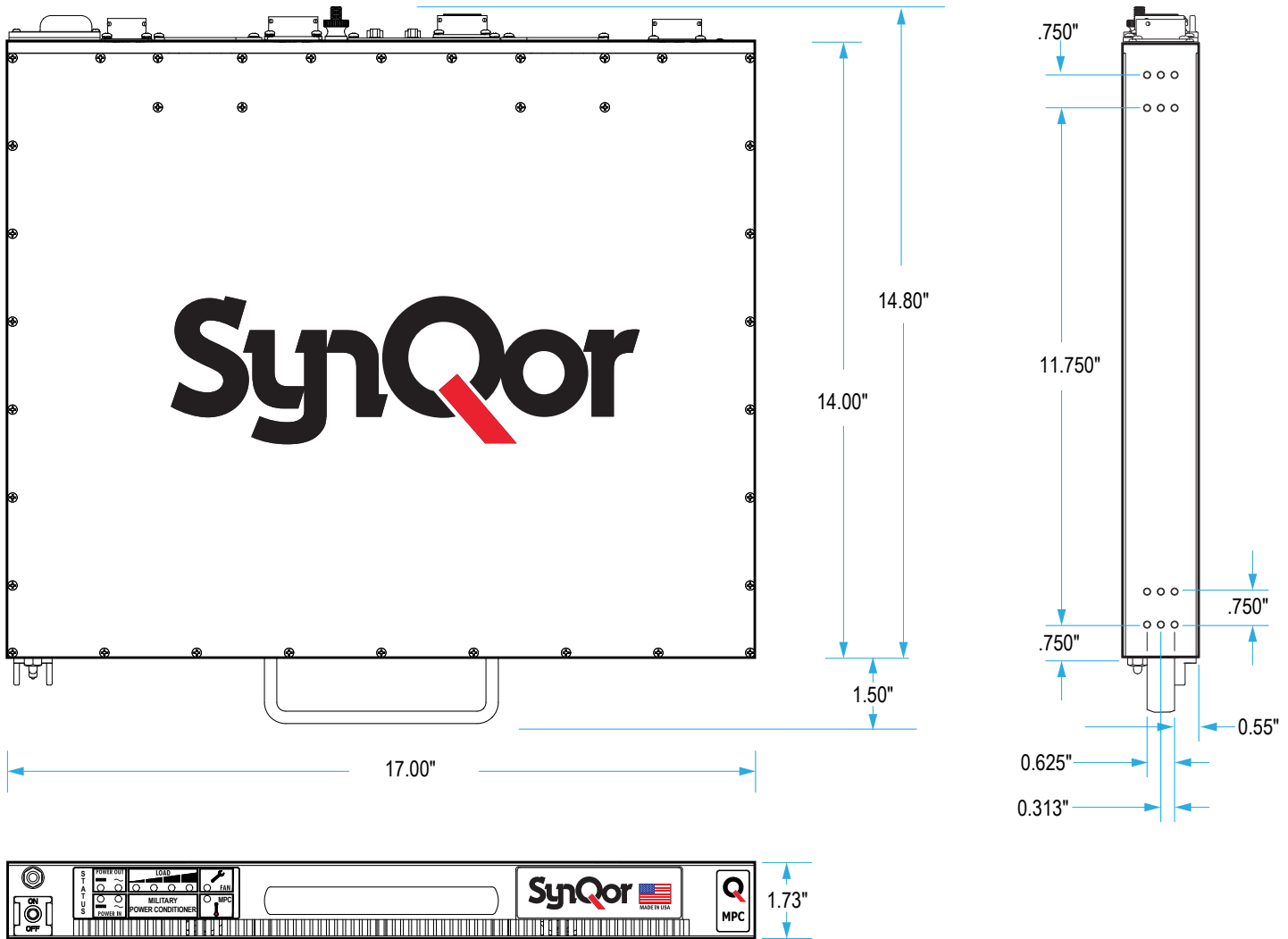

MPC Efficiency

Figure 1 shows the typical efficiency with which the MPC-1500 series power conditioner delivers power to its AC OUTPUT from a 230 Vrms AC INPUT, an 115 Vrms AC INPUT or a 28 V DC INPUT. Units with the “Electronic Breaker” option installed can be up to 1% less efficient at full load.

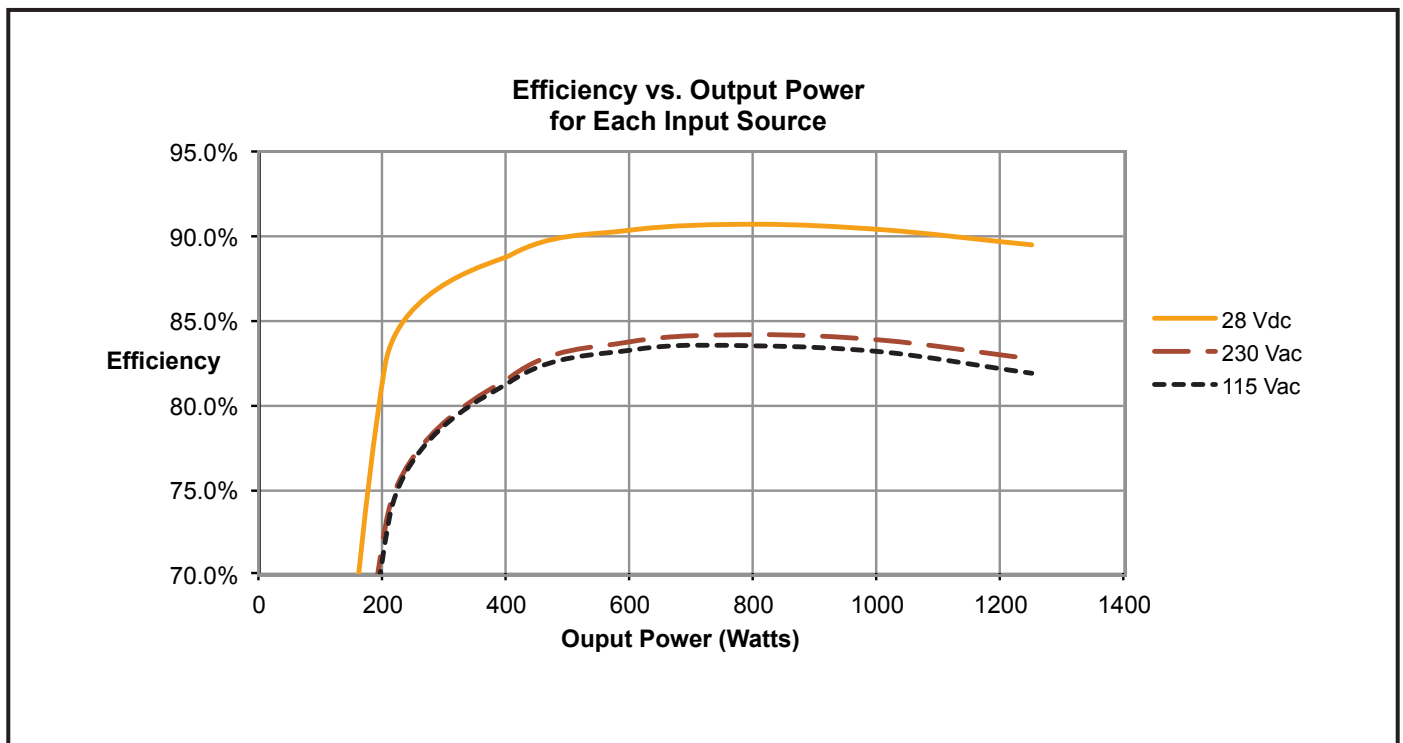

Figure 1

Total Output Power that can be derived from the AC INPUT

The total MPC output power (the AC OUTPUT power plus the optional DC OUTPUT power) for the MPC-1500 series is rated at 1250 W for an ambient temperature as high as 55°C (131°F). It draws this power first from the AC INPUT (if its voltage is within range) and then the DC INPUT (if its voltage is within range).

However, when the AC INPUT voltage is at the low end of its range (<90 Vrms) or the ambient temperature is at the high end of its range (>45°C/113°F) the MPC will not be able to deliver its full rated output power in the steady-state without switching over to the DC INPUT (if it is available and >22 Vdc). Figure 2 indicates the total steady-state output power that the MPC can derive **from the AC INPUT** under these extreme conditions. See Figure 3 for information on transient conditions.

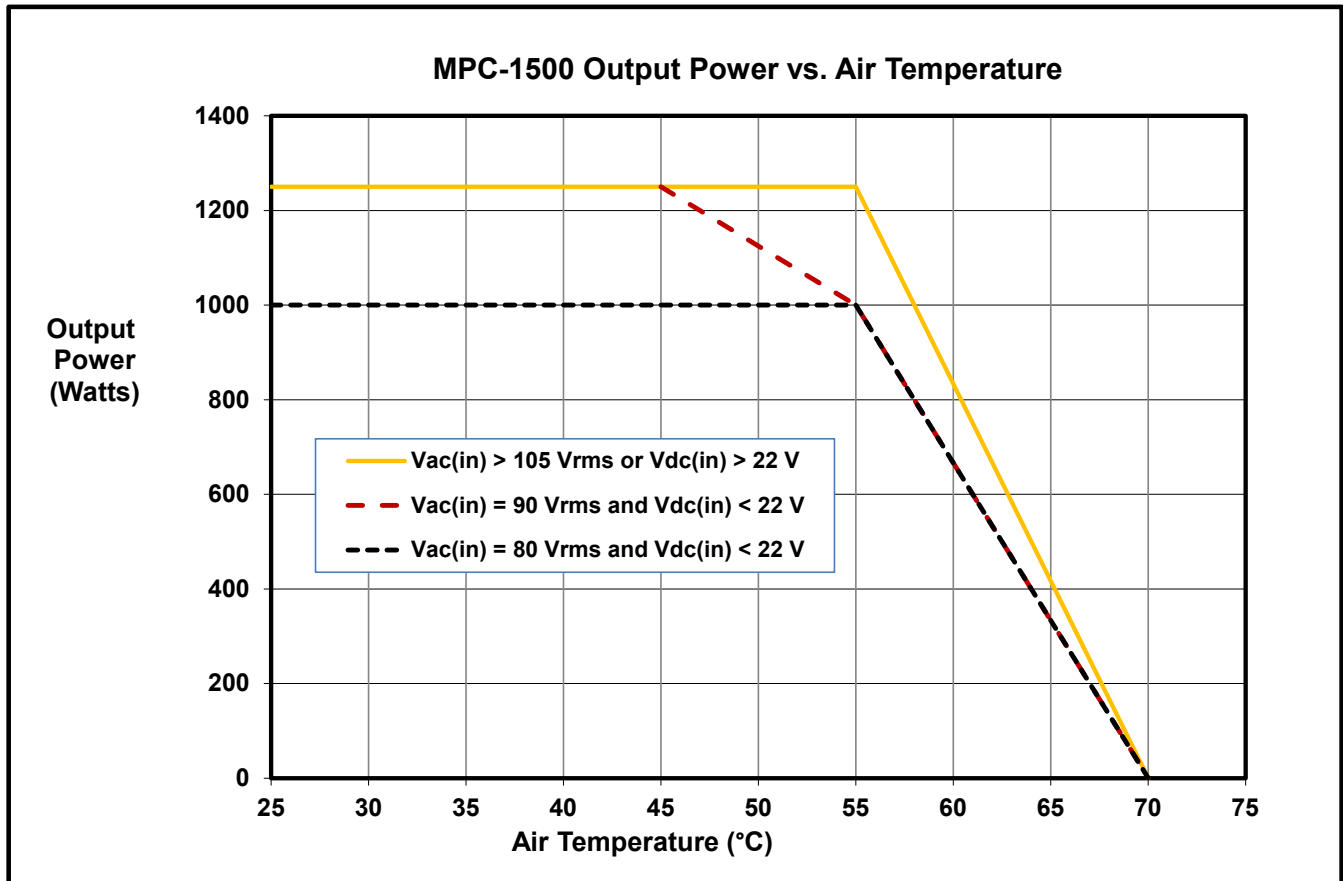

Figure 2

- If the AC INPUT voltage is above 105 Vrms, then the MPC can deliver its full rated output power of 1250 W from the AC INPUT for an ambient temperature as high as 55°C (131°F) without needing to switch over to the optional DC INPUT.
- If the AC INPUT is between 90 Vrms and 80 Vrms then the total output power that can be derived from the AC INPUT linearly decreases from 1250 W at 90 Vrms to 1000 W at 80 Vrms (except for at the high end of the ambient temperature range – see below). For example, the total output power that could be derived from the AC INPUT would be 1125 W at 85 Vrms as long as the ambient temperature is not above 50°C (122°F). If the total output power is greater than this derated value, the MPC will switch to the DC INPUT (if it is available and >22 V).
- If the AC INPUT voltage is 90 Vrms **AND** the ambient air temperature is above 45°C (113°F), the total output power that can be derived from the AC INPUT linearly decreases from 1250 W at 45°C (113°F) to 1000 W at 55°C (131°F). For example, the total output power that could be derived from the AC INPUT would be 1125 W at an AC INPUT voltage of 90 Vrms and an ambient temperature of 50°C (122°F). A higher output power than this would cause the MPC to switch over to its DC INPUT.

- When the AC INPUT voltage is between 105 Vrms and 90 Vrms **AND** the ambient temperature is between 45°C and 55°C, the total output power that can be derived from the AC INPUT can be calculated by linearly interpolating between the curves shown. For example, the total output power that can be derived from the AC INPUT when the voltage is 97.5 Vrms would be 1250 W up to an ambient temperature of 50°C (122°F) and then derate to 1125 W at 55°C (131°F).

Furthermore, there is a limited (and uncommon) range of AC INPUT voltage between 132 Vrms and 160 Vrms in which the total output power that can be derived from the AC INPUT is also derated, as shown in the graph below.

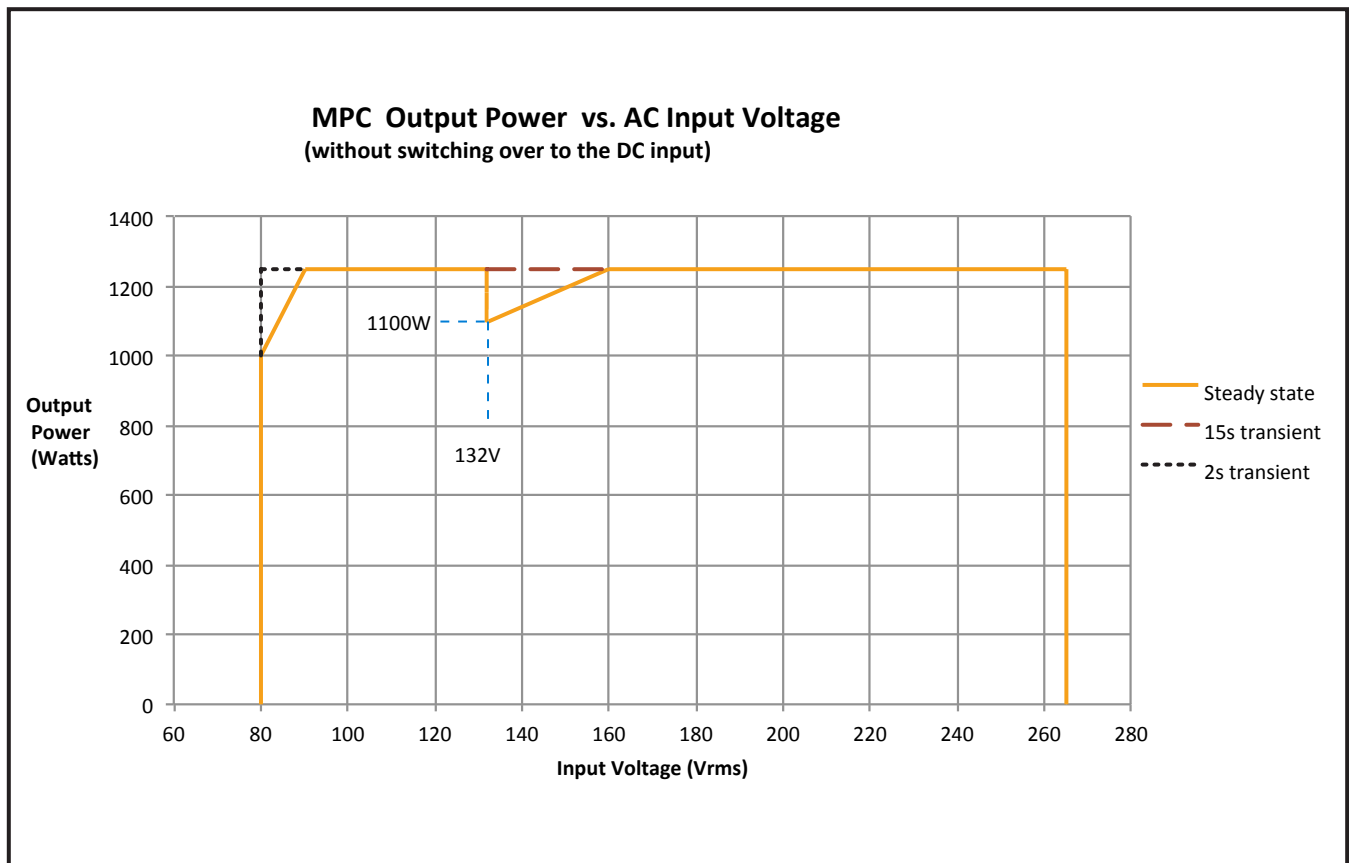

Figure 3

Note that the full rated output power of 1250 W can be derived from the AC INPUT having a voltage within this uncommon range for 15 seconds before the MPC will switch over to the DC INPUT. Also note that the MPC can drive it full rated power for a 2 second interval even if the AC INPUT voltage drops below 90 Vrms.

Power Cable Wiring Diagram

Looking at the rear panel, the MPC connector terminals have the following functions and locations:

AC INPUT	
Pin	Function
A	Line
B	Neutral
C	No Connect
D	Ground

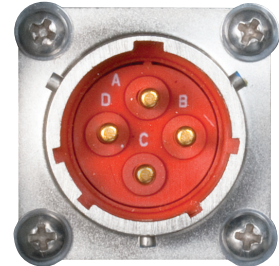
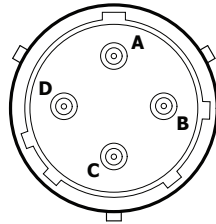

DC INPUT	
Pin	Function
G, F, E	+V _{IN}
B, C, D	V _{IN} Return
A, H	No Connect

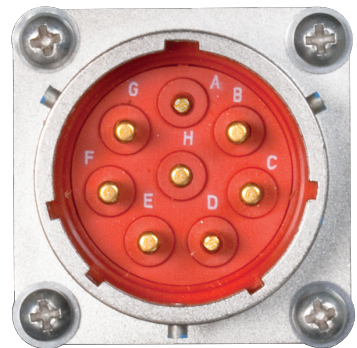
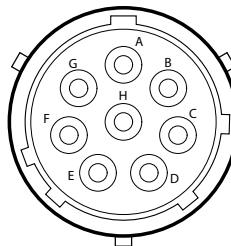

AC OUTPUT	
Pin	Function
A	Line
B	Neutral
C	No Connect
D	Ground

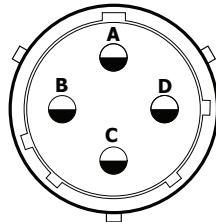

DC1 OUTPUT	
Pin	Function
C, D	+V _{OUT}
A, B	V _{OUT} Return

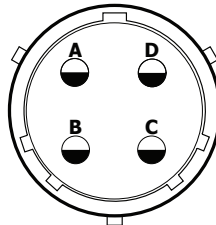

DC2 OUTPUT	
Pin	Function
G, F, E	+V _{OUT}
B, C, D	V _{OUT} Return
A, H	No Connect

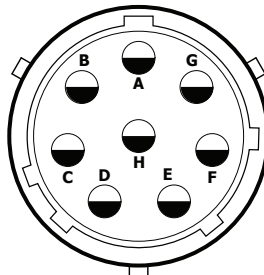

Power Cable Wire Size

SynQor recommends the following cables for use with the MPC-1500 Series:

AC Input:	SYN-9101	MPC connection to NEMA 5-20 Plug, 10'
	SYN-9104	MPC connection to NEMA 5-15 Plug, 10'
	SYN-9102	MPC connection to Hardwire Termination, 10'
AC Output:	SYN-9131	MPC connection to NEMA 5-20 Receptacle, 10'
	SYN-9130	MPC connection to Hardwire Termination, 10'
DC Input:	SYN-9151	MPC connection to Ring Connectors, 10'
	SYN-9154	MPC connection to NATO Connector, 10'
DC1 Output:	SYN-9171	MPC connection to Fork Connectors, 10'
	SYN-9172	MPC connection to Hardwire Termination, 10'
DC2 Output:	SYN-9174	MPC connection to Hardwire Termination, DC2 Output, 10'
	SYN-9175	MPC connection to Fork Connectors, DC2 Output, 10'

Other options may be available. Contact info@synqor.com or visit the website: www.synqor.com for more information. If it is necessary to develop custom cables for your application, please read through the following section for some important considerations. Damage caused by improper wiring of cables will not be covered under SynQor's warranty.

Both the input and output cables of the MPC carry substantial current, and since the wires in these cables have resistance the current flowing through them causes a voltage drop from one end of the cable to the other. In other words, the voltage across the cable at its downstream end is smaller than the voltage across the cable at its upstream end. Mathematically, the amount that the voltage drops is equal to the resistance of the cable's wire multiplied by the current flowing through the wire. It is therefore **important** to make sure that the **resistance of the cable's wire is small** enough to keep this voltage drop to an acceptably small value.

While this is an issue for all of the power cables, **it is particularly important for the DC INPUT and DC2 Output cables** because the current flowing through it is very high (as high as 65 A for the MPC-1500 Series) and the voltage across it is already relatively small (as low as 22 V). In fact, a common problem that arises (when the DC INPUT cable has too small a wire) is that the voltage seen at the DC INPUT of the MPC falls below the minimum specified value of 22 V even though the voltage at the source of the DC power is greater than 22 V.

The resistance of a wire depends directly on its length. A wire twice as long as another will have twice the resistance, holding all other things constant. The resistance also depends on the reciprocal of the cross-sectional area of the wire, which in turn depends on the square of the wire's diameter. A wire with half the diameter of another will therefore have four times the resistance, holding all other things constant.

Therefore, the longer a cable is, the more important it is that the wire's diameter be large. Alternatively, a cable can have multiple pairs of wires to achieve a larger "effective wire diameter". This second approach gives a more flexible cable. For 10 ft long cables, SynQor recommends that for the MPC-1500 Series:

- The AC INPUT cable have 3 wires (one for the ground) of 12 AWG
- The DC INPUT cable have 6 wires (three for each connection) of 12 AWG
- The AC OUTPUT cable have 3 wires (one for ground) of 12 AWG
- The DC1 OUTPUT cable have 4 wires (two for each connection) of 12 AWG
- The DC2 OUTPUT cable have 6 wires (three for each connection) of 12 AWG

Additional details about the effects of a resistance-related voltage drop are included in "Trouble-Shooting Guide - Cable wire resistance is too high".

Set-Up

The recommended procedure for setting up the MPC is the following:

- Make sure the AC BREAKER on the rear panel of the MPC is in the OFF position.
- Connect the ground wire to the ground stud on the rear panel of the MPC.
- Connect all OUTPUT cables, first to the MPC and then to the various loads.
- **VERIFY** that the optional DC OUTPUT cable(s) connect to the MPC and the load with the correct polarity.
- Connect the USER I/O cables.
- Connect all INPUT cables, first to the MPC and then to the various sources.
- An overcurrent protect and disconnect device should be installed on the DC INPUT circuit. An example of a suitable device is a Carling Technologies, C- series, 80 A, 65 Vdc CA1-B0-14-680-321-J circuit breaker. (www.carlingtech.com)
- **VERIFY** that the optional DC INPUT cable is connected to the MPC and the source of DC power with the correct polarity.
- Turn on the sources (if they have an upstream breaker).
- Move the AC BREAKER on the rear panel of the MPC to the ON position.

Note: Be careful to not toggle the ON/OFF switch during the setup. Doing so could cause the MPC to turn on and present a hazardous voltage at its output.

Start-Up

- **VERIFY** that all connections to the MPC are correct.
- If either the AC source or the DC source (or both) is present and within specifications, the color of the LED above the ON/OFF switch will be amber. This indicates that the MPC is in standby mode and ready to turn on.
- Momentarily push the ON/OFF switch on the front panel of the MPC upward. The switch can then be released and it will return to its normal (neutral) position.
- The MPC will immediately enable its outputs (assuming there is no fault condition). The color of the LED above the ON/OFF switch will change to green. The LEDs on the front panel will indicate the amount of power being delivered to the load and the input source from which this power is being drawn.

Shut-Down

- Shut down the equipment connected to the MPC.
- Push the ON/OFF switch on the front panel of the MPC downward and hold it in this position for 1 second (or more). The color of the LED above the ON/OFF switch will change to amber (if one or both input power sources are present) or it will be off (if no power sources are present). The switch can then be released to return to its normal position.
- The MPC will disable its outputs and shut down.
- It is not necessary to move the AC BREAKER on the rear panel of the MPC to the OFF position.

Power Cable Connections/Disconnections While Operating

For safety reasons, it is highly recommended that the input and output power cables be connected to the MPC before the source of AC or DC input power is turned on, and before the MPC is turned on (see **Section I: Warnings** and the **SET-UP** section above). Similarly, it is **highly recommended** to first turn off the MPC and the sources of input power before any power cables are disconnected from the MPC.

However, the SynQor MPC is capable of having any of its input or output power cables connected at any time (if safely done), including when the MPC is turned on and delivering power to the load. For instance:

- Even if the MPC is turned on, one can connect or disconnect the input power cables without harming the MPC or disrupting power delivery to the load. If no input power source is available, the MPC will shut down. When there is an external source of power connected to the MPC, the unit will draw power from that source, choosing the AC INPUT source first, if present, and then the optional DC input source. The transfer from one source of power to another is seamless.
- Even if the MPC is turned on, one can connect or disconnect an output power cable without harming the MPC or disrupting power delivery to a load that might be connected to the other output.

NOTE that disconnecting an input or output power cable while that cable is handling power will likely cause an arc to form as the terminals are pulled apart. This arcing is not harmful to the MPC, although if done enough times it will degrade the connector to the point where it will need to be replaced. This problem is particularly acute for the **DC INPUT and DC2 Output cables** because its current is so high. Disconnecting these cables while a large current is flowing is **not recommended**.

ALSO NOTE that when the MPC is turned on and delivering power to a load, and then another piece of equipment is connected to the same output, it is possible that this connection will momentarily disrupt the quality of the MPC's output voltage. For instance, consider the case where the AC OUTPUT power cable has a terminal strip that allows several loads to be connected to it. If the MPC is turned on and delivering power to several of these loads and then another load is connected to the terminal strip, it is possible that this new load will momentarily draw a large surge of current as it starts up. If this happens, the output of the MPC could reach its maximum current limit, and the MPC will reduce its output voltage to keep the current from getting any larger. This reduction in voltage will be corrected once the new load reaches its normal mode of operation, but in the mean time the reduction of the MPC's output voltage might cause one or more of the other loads to malfunction. Whether or not this will be a problem depends on the characteristics of the various loads.

Cooling System

The SynQor MPC-1500 Series products are cooled by fans that draw air into the intake below the front panel and exhaust it out the two fan ports on the rear panel. Care should be taken to ensure there is no obstruction to this airflow, either at the front intake or the rear exhaust ports. Similarly, care should be taken to avoid obstructing the fan blades.

The speed of the cooling fans is automatically controlled to provide adequate MPC cooling while extending the life of the fan bearings. Under low ambient temperature and/or low MPC output power the fans will be driven at a low speed. If the ambient temperature and output power are such that the MPC cannot otherwise maintain its specified maximum temperature for its internal circuitry, the fans will momentarily be driven at a speed that exceeds their rated long-term running speed. There is an LED on the front panel that indicates the speed of the fans.

If the ambient temperature is low enough (for the level of power being delivered to the load), the fans may not be on. This is not a malfunction. It is done to preserve the life of the fans. If the fans are off, check the Fan Service Required LED on the front panel. If it is GREEN, the fans are functioning properly and simply not needed under the present conditions.

The fans are weather-proof and water-proof.

The MPC has two fans to provide redundancy for these exposed, moving components. With only a single operating fan the MPC is still able to deliver 100% rated power at an ambient temperature as high as 40°C, and it is able to deliver 80% of its rated power at an ambient temperature as high as 55°C.

The MPC-1500-1S “Shallow Rack” form factor has Field Replaceable fans that can be serviced by the user.

The MPC-1500-1U fans cannot be serviced by the user. The unit must be returned to the factory for repair should a fan fail.





Front Panel Indicators

To indicate the status of the MPC, there is one LED above the ON/OFF switch on the left side of the front panel of the MPC and an additional 10 LEDs on the front panel. There is also an audible alarm. These indicators are described in this section.

LEDs

LED above the ON/OFF switch

This LED has four possible indications, according to the table below:

LED Appearance	Description	Indication
	Green	MPC is Running (Outputs are Enabled)
	Amber	MPC is on Standby (Outputs are Enabled)
	Red	MPC has a Fault Condition
	Off	MPC is Off



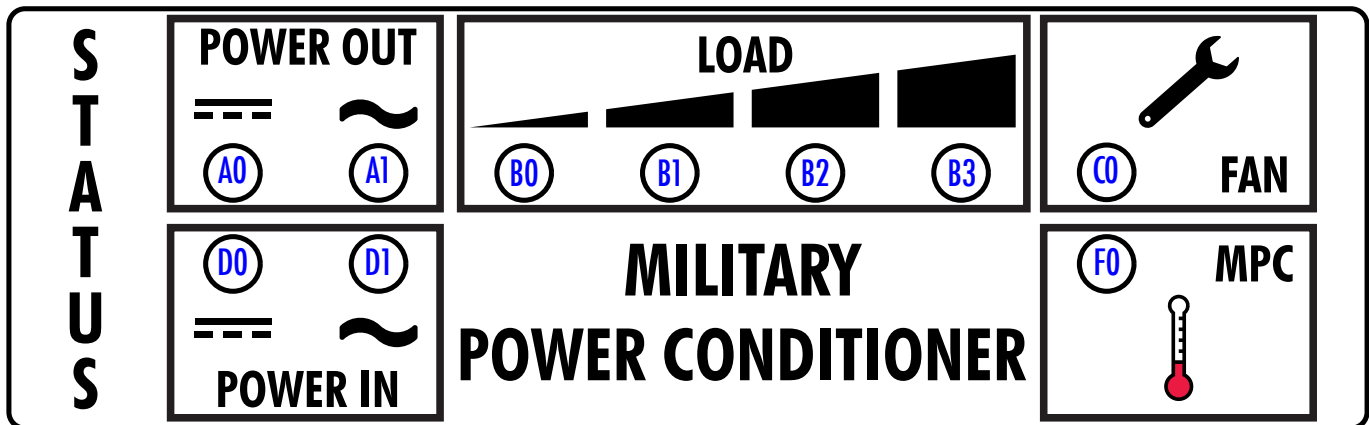

LEDs on the Front Panel

Each front panel has 10 LEDs, as shown below, that indicated the status of the operation of the MPC:







Power-In Indicators (LEDs in positions D0 and D1)

The LED in position D0 indicates the status of the optional DC INPUT and the LED in position D1 indicates the status of the AC INPUT, according to the table below:

LED Appearance	Description	Indication
	Green	<i>Input is Ready to Provide Load Power</i>
	Pulsing Green	<i>Input is the One Presently Selected as the Source of Power</i>
	Amber	<i>Input has Returned within Range and Diagnostic Tests are Being Performed</i>
	Off	<i>Input is Not within Range (Or the DC Input Option is not Installed)</i>

Power-Out Indicators (LEDs in positions A0 and A1)

The LED in position A0 indicates the status of the optional DC OUTPUT and the LED in position A1 indicates the status of the AC OUTPUT, according to the table below:

LED Appearance	Description	Indication
	Green	<i>MPC is On and the Output Voltage is Within Range</i>
	Amber	<i>MPC is On but the Output Voltage is Out of Range</i>
	Red	<i>MPC is Off and the Output Voltage is Within Range</i>
	Off	<i>MPC is Off (Or the DC Output Option is not Installed)</i>





Load Power Indicators (LEDs in positions B0 – B3)

The LEDs in positions B0 through B3 indicate the total output power of the MPC (The AC OUTPUT power plus the optional DC OUTPUT power) according to the table below:

LED Appearance	Description	Indication
	<i>B0 Dimmed Green; B1-B3 Off</i>	<i>Total Load Power <25%</i>
	<i>B0 Green; B1 Dimmed Green; B2-B3 Off</i>	<i>Total Load Power <50%</i>
	<i>B0, B1 Green; B2 Dimmed Green; B3 Off</i>	<i>Total Load Power <75%</i>
	<i>B0, B1, B2 Green; B3 Dimmed Green</i>	<i>Total Load Power <100%</i>
	<i>B0; B1; B2 Green; B3 Blinking Red</i>	<i>Total Load Power ≥100%</i>



MPC Cooling System Indicator (LED in position F0)

The LED in position F0 indicates the temperature and status of the cooling system for the MPC according to the table below:

LED Appearance	Description	Indication
	Green	Moderate MPC Temperature (Fans Running at 33%)
	Blinking Green	Warm MPC Temperature (Fans Running at 67%)
	Amber	Elevated MPC Temperature (Fans Running at 100%)
	Red	Maximum MPC Temperature (Fans Running at 110%)

Fan Service Required Indicator (LED in position C0)

The LED in position C0 indicates whether the two cooling fans in the rear panel of the MPC are OK or if their performance is degraded, according to the table below:

LED Appearance	Description	Indication
	Green	Both Fans are OK
	Amber	One or Both Fans Have Recently Had Degraded Performance and Diagnostic Tests are Being Performed
	Red	One or Both Fans Presently Have Degraded Performance

Audible alarm

For critical situations a pattern of audible tones will be repeated every 5 seconds, according to the table below. This audible alarm can be **silenced** by holding the ON/OFF switch on the front panel in the “UP” position until a chirp is heard. A new alarm condition will cause the audible alarm to be reactivated. Contact Factory for instructions on how to permanently silence the alarm.

Number of Tones in Pattern	Indication
Two	Load Power is greater than or approaching 100% Rated Power
Three	Fault Appears on the AC Output MPC Must be Turned Off and Back On to Reset Fault

Operating Environment

The SynQor MPC-1500 Series is designed for the extreme environmental conditions of military and aerospace applications. All the electronic circuitry is contained in a sealed, weather-proof, shock-proof chamber constructed of die-cast aluminum. Only the redundant, water-proof cooling fans are exposed to the environment. The MPC will shut down if it is too hot.

The MPC (with cables connected or connector covers installed) has been qualified to the following requirements of MIL-STD-810G:

MIL-STD-810G Test Method	Name	Procedure	Details
500.5	Low Pressure	I, II and III	<ul style="list-style-type: none"> ▪ 15,000 ft. operating ▪ 40,000 ft. storage
501.5	High Temperature	I and II	<ul style="list-style-type: none"> ▪ +55°C operating ▪ +65°C storage
502.5	Low Temperature	I and II	<ul style="list-style-type: none"> ▪ -20°C operating ▪ -20°C storage
503.5	Temperature Shock	I	<ul style="list-style-type: none"> ▪ 10 cycles; >10°C/minute
506.5	Rain	I	<ul style="list-style-type: none"> ▪ 4" rain/hour ▪ 40 mph wind velocity
507.5	Humidity	NA	<ul style="list-style-type: none"> ▪ >95%
508.6	Fungus	NA	<ul style="list-style-type: none"> ▪ 28 day test
509.5	Salt Fog	NA	<ul style="list-style-type: none"> ▪ 5% salt solution ▪ 2 cycles (24 hr wet/24 hr dry)
510.5	Sand and Dust	I and II	<ul style="list-style-type: none"> ▪ 20 mph blowing dust ▪ 40 mph blowing sand
514.6	Vibration	Category 5	<ul style="list-style-type: none"> ▪ 5 Hz (300 RPM) ▪ Loose Cargo
514.6	Vibration	Category 7	<ul style="list-style-type: none"> ▪ General Exposure
514.6	Vibration	Category 8	<ul style="list-style-type: none"> ▪ C-130 Aircraft level
514.6	Vibration	Category 9	<ul style="list-style-type: none"> ▪ General Exposure
514.6	Vibration	Category 24	<ul style="list-style-type: none"> ▪ PSD = 0.04 g²/Hz; 20-2000 Hz ▪ Operating
516.6	Shock	I, IV and VI	<ul style="list-style-type: none"> ▪ 20 g/20ms; 40 g/11 ms; 75 g/6 ms ▪ 48 inch drop in transit case ▪ 30 degree tilt and drop
528	Mechanical Vibrations of Shipboard Equipment	I	<ul style="list-style-type: none"> ▪ Operating

General Considerations

The MPC supports two different paralleling schemes for the AC output: standard paralleling and expanded paralleling. With standard paralleling, up to three MPC units can be combined to function as a single machine. A fault on any one unit will cause the entire system to shut down. With expanded paralleling, up to 32 MPC units can be combined to form high power single phase, split-phase and 3-Phase systems. An electronic breaker on the hot AC output wire provides fault-tolerant, glitch-free operation should one MPC unit fail. This allows users to add extra MPC units to the system for N+1 redundancy, or more generally N+M redundancy.

Standard vs. expanded paralleling is determined by the “AC Output Neutral Wire” option in the MPC part number. See the table below. Standard paralleling units cannot be mixed with redundant parallel units in multi-unit systems.

Ordering Information: Standard Vs. Redundant Parallel		
	AC Output Neutral Wire option	Example PN
Single Unit (no paralleling)	-G	MPC-1500-S-1U-W1GS00-ECE
Standard Parallel	-F	MPC-3000-S-2U-W1FS00-ECE
Expanded Parallel	-R	MPC-1500-S-1U-W2RS00-ECE

Note: When combining MPC units into the configurations described in this section, each MPC must internally have the neutral wire of its AC OUTPUT floating, rather than connected to its chassis. This requires that all the MPC units have the “F” option for standard parallel units and “R” option for expanded parallel units regarding the AC OUTPUT neutral wire connection. Check the MPC part numbers to be sure this is the case before ordering.

Wiring Caution

WARNING: LETHAL VOLTAGES MAY BE PRESENT ON MPC AC OUTPUT CONNECTIONS. ALWAYS REMOVE AND INPUT POWER BEFORE MAKING MULTI-UNIT AC OUTPUT CONNECTIONS. ALL AC OUTPUT CABLE CONNECTORS MUST BE INSTALLED DURING OPERATION AS A DISCONNECTED CABLE CONNECTOR MAY HAVE EXPOSED VOLTAGE PRESENT FROM ANOTHER UNIT IN THE GROUP .

Standard Paralleling -F Option

With standard paralleling, up to three SynQor MPC units with identical model numbers can be combined in various ways to achieve:

- Higher output power
- Higher output voltage
- Multiple output phases
- A balanced or unbalanced load for a 3-Phase AC input source

A configuration-specific CONFIGURATION cable determines each MPC unit's role in a standard parallel system. These CONFIGURATION cables are available from SynQor, and the proper part number for any configuration is given in the pages that follow. These CONFIGURATION cables are unique to –F option paralleling and cannot be used with –R option MPC units.

Configuration-specific OUTPUT and/or INPUT power cables are also required. These power cables can be assembled by the user following the wiring diagrams shown below, or they can be ordered from SynQor using the proper part number given in the pages that follow.

In a standard parallel system, the AC output will remain off until all MPC units are enabled. Each unit must be enabled by actuating the front panel switch “on”, or by sending the appropriate signal over the USER I/O cable. If any MPC unit is “off”, all of the MPC units will disable their outputs. If any MPC unit cannot deliver output power because it cannot draw power from its AC INPUT or its DC INPUT, or because there is an internal fault, then all of the MPC units will disable their outputs.

Expanded Paralleling -R Option

The “R” option adds an electronic breaker to the AC output of the MPC to provide fault-tolerant, glitch-free parallel operation. Should one unit experience a fault that could otherwise cause the AC output to collapse, the breaker disconnects the failed unit from the AC bus. This allows the remaining units to continue delivering power, provided the remaining units can support the total load power. This allows users to create N+1 or N+M redundant systems.

Additionally, the “R” option increases the total number of units in a multi-unit system to 32. These units can be arranged to form single-phase, Split Phase, and 3-Phase systems. Systems with multiple phases will be N+1 or N+M redundant on each phase.

A failed unit can be removed and replaced while the system AC output is active. Special consideration must be taken when connecting the outputs to avoid electric shock. It is strongly recommended that the system AC output be disabled before a unit is removed or replaced.

CONFIGURATION cables for two unit and three unit single-phase systems are offered as standard products. See the following pages for details. These cables are unique to the –R paralleling option, and cannot be used with –F paralleling option units. Contact the SynQor factory for Single Phase systems larger than 3 MPC units, or for Split Phase and 3-Phase systems.

Systems created using expanded parallel MPC units will be fault-tolerant to the following events:

- Complete loss of power source (AC INPUT, DC INPUT)
- Hardware failure of the AC input stage
- Hardware failure of the AC output stage

The enable and disable behavior of systems using expanded paralleling is different from systems using standard paralleling. For expanded paralleling, all MPC units will be enabled if one MPC is enabled. Units can be enabled by actuating their front-panel “on” switches or by sending the appropriate signal over their USER I/O cables.

Sending a “OUTPUT DISABLE” command to a MPC will cause only that MPC to be disabled. Other MPC units in the system will continue running. Sending a “SYSTEM DISABLE” command over the RS-232 interface will cause all MPC units in a system to turn off simultaneously.

For a detailed description of the terminal interface see the SynQor website at:

http://www.synqor.com/UPS/documents/UPS_User_Commands.pdf

Parallel Configurations of the AC OUTPUTS: Up to Three Units

Multi-unit Configurations

The chart below shows four possible ways the AC OUTPUTS of up to three SynQor MPC units can be connected together. Each configuration will be discussed in more detail in the following pages.

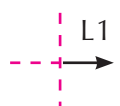
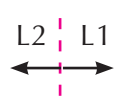
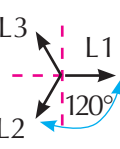
Number of MPC Units	Output Configuration	Phasor Diagram	# of Output Phases	Output Voltage	Output Current per phase	Total Output Power	Configuration Cable	Redundant Parallel Configuration Cable
2	Parallel		1	L-N: $1 \times V_{\text{rated}}$	$2 \times I_{\text{rated}}$	$2 \times P_{\text{rated}}$	SYN-9311	SYN-9341
3	Parallel		1	L-N: $1 \times V_{\text{rated}}$	$3 \times I_{\text{rated}}$	$3 \times P_{\text{rated}}$	SYN-9315	SYN-9343
2	Series Split Phase		2	L-N: $1 \times V_{\text{rated}}$ L-L: $2 \times V_{\text{rated}}$	$1 \times I_{\text{rated}}$	$2 \times P_{\text{rated}}$	SYN-9313	N/A
3	3 Phase-Y		3	L-N: $1 \times V_{\text{rated}}$ L-L: $1.73 \times V_{\text{rated}}$	$1 \times I_{\text{rated}}$	$3 \times P_{\text{rated}}$	SYN-9317	N/A

Note that the chart shows the SynQor part number for the CONFIGURATION cable required for each configuration.

The chart shown above focuses on how the AC OUTPUTS of multiple MPC units could be connected. Of course, there are multiple ways in which the INPUTS (both AC and DC) could be connected, as well. They could be connected to the same source, or they could be connected to separate sources. The possibilities will be discussed at the end of this section.

Select the “F: Floating” or “R: Redundant” option when ordering MPC units configured in this manner.

Contact the SynQor factory for redundant Split Phase systems, redundant 3-Phase systems, or redundant Single Phase systems with more than three units.

Parallel Connection of the AC OUTPUTS

Two or three SynQor MPC units can have their AC OUTPUTS connected in parallel to deliver two or three times the output power and output current of a single unit. Units can also be connected to form 1+1 or 2+1 redundant systems.

Two MPC units with AC OUTPUTS Paralleled

For two MPC units having their outputs connected in standard parallel or redundant parallel, the wiring diagram for the AC OUTPUT cables and the CONFIGURATION cable is shown below:

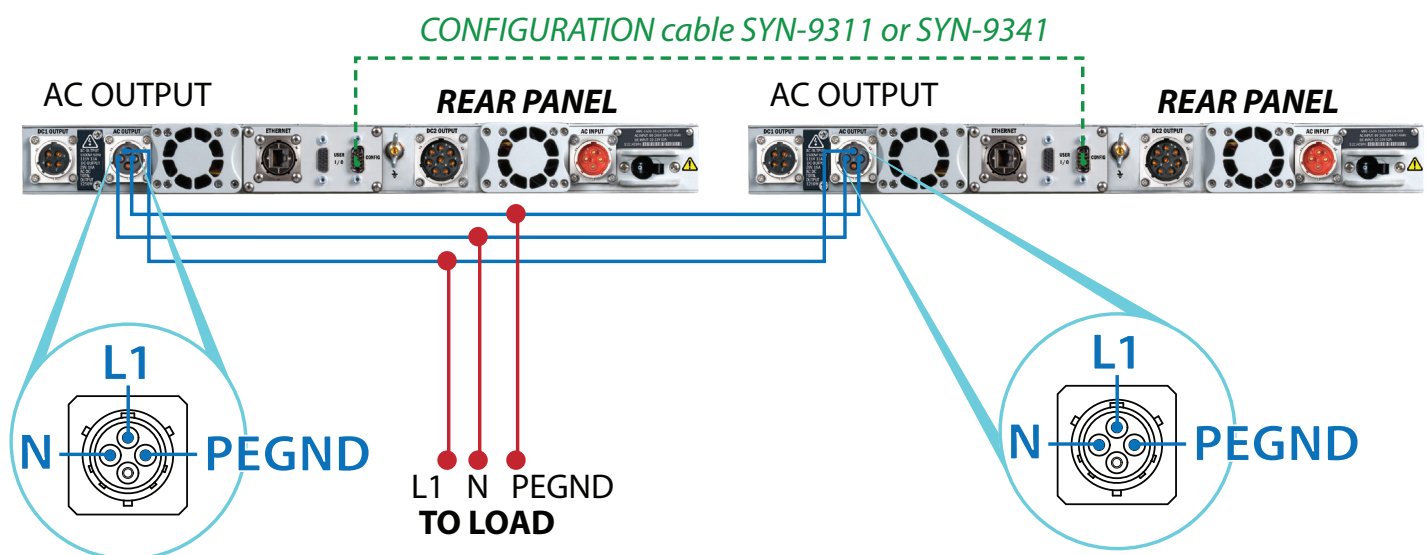

When ordering, select the “F: Floating” or “R: Redundant” option for MPC units configured in this manner. Use CONFIGURATION cable SYN-9311 for standard parallel and SYN-9341 for redundant parallel.

If the user is providing the AC OUTPUT cable, the cable sections shown above in either blue or red should have the following minimum wire size, depending on whether the AC OUTPUT of the MPC units is 115 Vac or 230 Vac.

MPC AC Output Voltage	Blue Cable Section Minimum Wire Size	Red Cable Section Minimum Wire Size
115 Vac	#14 AWG (2.5 mm ²)	#10 AWG (6mm ²)
230 Vac	#16 AWG (1.5 mm ²)	#12 AWG (4mm ²)

Three MPC units with AC OUTPUTS Paralleled

For three MPC units having their outputs connected in standard parallel or redundant parallel, the wiring diagram for the AC OUTPUT cables and the CONFIGURATION cable is shown below:

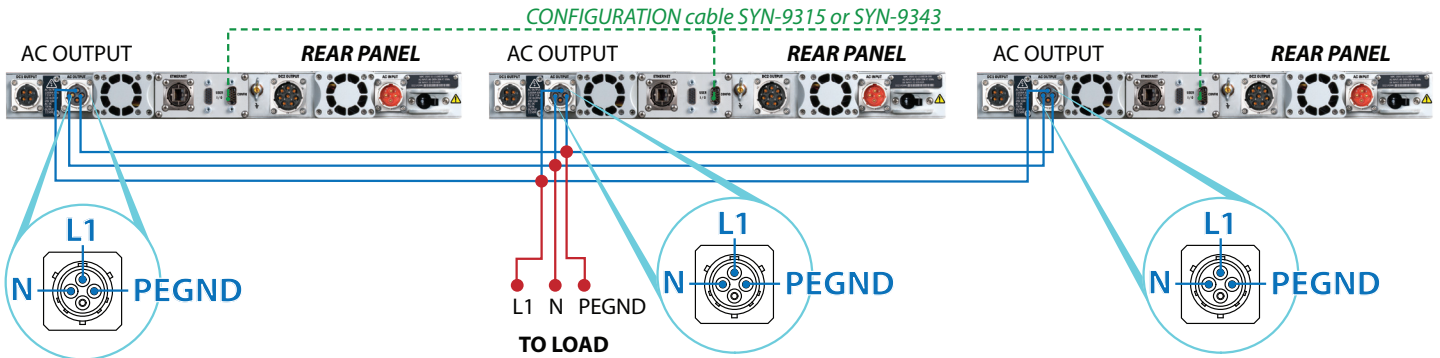

When ordering, select the options “F: Floating” for standard parallel, or “R: Redundant” for redundant parallel. Use CONFIGURATION cable SYN-9315 for standard parallel and SYN-9343 for redundant parallel.

If the user is providing the AC OUTPUT cable, the cable sections shown above in either blue or in red should have the following minimum wire size, depending on whether the AC OUTPUT of the MPC units is 115 Vac or 230 Vac.

MPC AC Output Voltage	Blue Cable Section Minimum Wire Size	Red Cable Section Minimum Wire Size
115 Vac	#14 AWG (2.5 mm ²)	#10 AWG (6mm ²)
230 Vac	#16 AWG (1.5 mm ²)	#12 AWG (4mm ²)

Series Split Phase Connection of AC OUTPUTS

Two MPC units can have their AC OUTPUTS connected in series to create an output voltage that is twice that of the output voltage of the individual MPC units. For instance, if the MPC units each create an 115Vac output, the series configuration will create a 230Vac output at twice the power level of a single unit. Or, if the MPC units each create a 230Vac output, the series configuration will create a 460Vac output at twice the power level of a single unit.

The center node between the two outputs in the series configuration should be considered the “neutral” wire, and therefore kept at a potential close to Protective Earth Ground (PEGND).

The other two AC OUTPUT wires (one from each MPC unit) are electrically “hot” (meaning at a high potential relative to the neutral or PEGND). One will be phase-shifted by 180 degrees (one-half cycle) from the other, meaning that when one hot wire is at its positive peak the other is at its negative peak, and vice versa. The voltage between these two hot wires is therefore twice that of either hot wire compared to the neutral wire. This configuration is called “Split Phase”. When ordering, select the “F: Floating” option for MPC units configured in this manner.

Contact the SynQor factory for N+1 redundant Split Phase systems.

The wiring diagram for the AC OUTPUT cables and the CONFIGURATION cable for the Split Phase configuration is shown below:

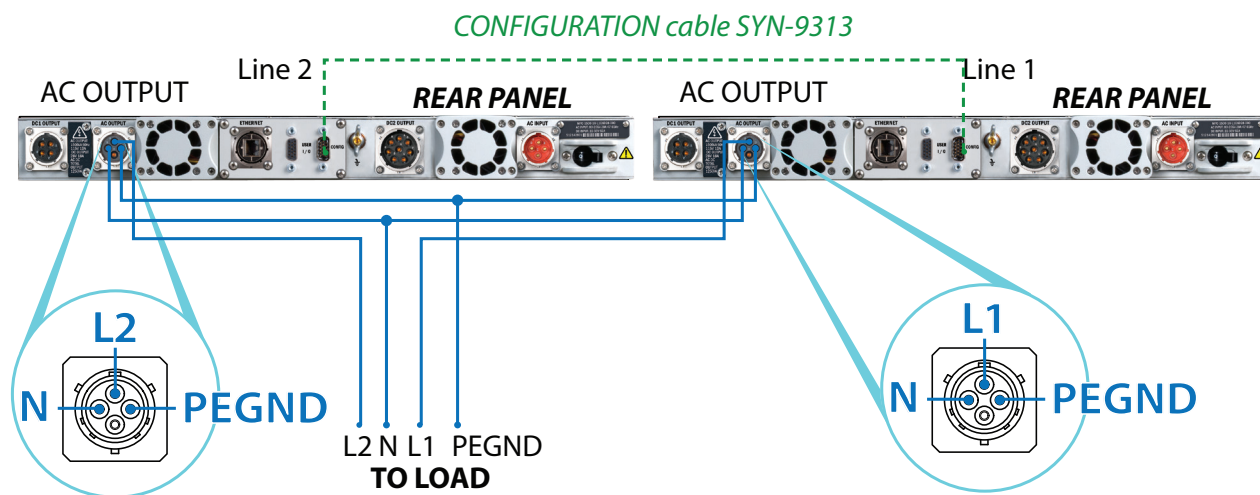

If the user is providing the AC OUTPUT cable, all the cable sections should have the following minimum wire size, depending on whether the AC OUTPUT of the individual MPC units is 115 Vac or 230 Vac.

MPC AC Output Voltage	Cable Minimum Wire Size
115 Vac	#14 AWG (2.5 mm ²)
230 Vac	#16 AWG (1.5 mm ²)

3-Phase Connection of AC OUTPUTS

Three MPC units can have their AC OUTPUTS connected such that they share a common “neutral” and then controlled such that their output voltages are phased by 120 degrees (one- third cycle) from each other. This creates a 3-Phase output where the line-to-neutral voltage is the rated voltage of the individual MPC units (e.g. 115Vac or 230Vac line-to-neutral) and the line-to-line voltage is 1.73 times higher (e.g. 200Vac or 400Vac line-to-line).

The wiring diagram for the AC OUTPUT cables and the CONFIGURATION cables for the 3-Phase configuration is shown below:

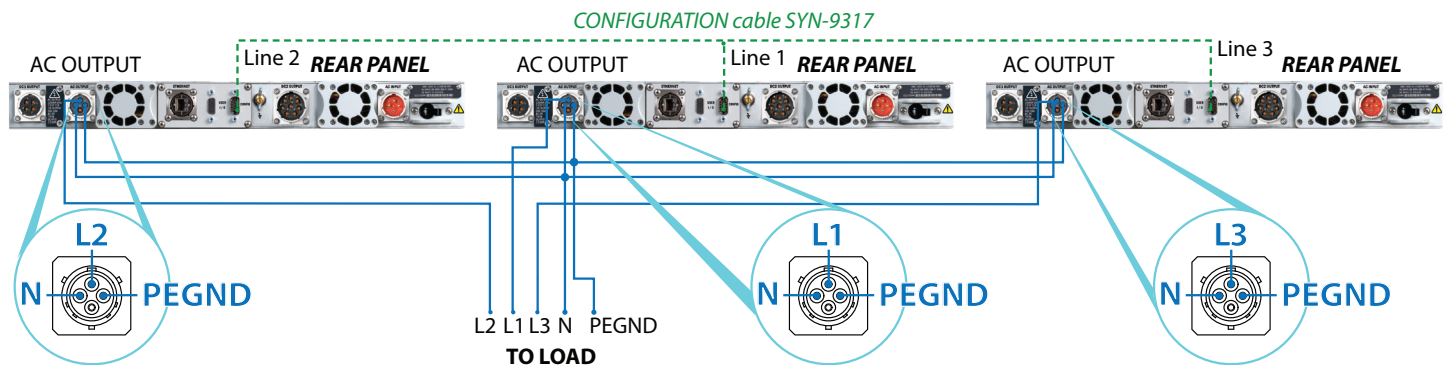

If the user is providing the AC OUTPUT cable, all the cable sections should have the following minimum wire size, depending on whether the AC OUTPUT of the individual MPC units is 115 Vac or 230 Vac.

MPC AC Output Voltage	Cable Minimum Wire Size
115 Vac	#14 AWG (2.5 mm ²)
230 Vac	#16 AWG (1.5 mm ²)

The “neutral” wire of the 3-Phase AC OUTPUT should be kept at a potential close to Protective Earth Ground (PEGND).

When ordering, select the “F: Floating” option for MPC units configured in this manner.

Contact the SynQor factory for N+1 redundant 3-Phase systems.

Note: The three connectors of the SYN-9317 CONFIGURATION CABLE are labeled “Line 1”, “Line 2” and “Line 3”. The MPC unit that receives the “Line 1” connector will have an AC OUTPUT that is phased 120 degrees (one-third cycle) ahead of the MPC unit that receives the “Line 2” connector, which in turn will have an AC OUTPUT that is phased 120 degrees (one-third cycle) ahead of the MPC unit that receives the “Line 3” connector. Connecting the three AC OUTPUTS to the three line wires of the AC OUTPUT cable in the proper order may be important for some loads, such as motors.

Parallel Configurations of the AC OUTPUTS: Up to 32 Unit -R option

The “R” option adds a single pole, electronic breaker to the hot wire of the AC output. This breaker allows for fault-tolerant, glitch-free operation of up to 32 MPC units in a multi-unit system. Single phase, split phase, and 3-phase systems can be formed. These systems can be N+1 or N+M redundant on each phase.

The figures below show the different system configurations that can be formed with “R” option units. Each system requires its own unique CONFIGURATION cable. Contact the SynQor factory to purchase system specific configuration cables. Note that configuration cables for two unit and three unit single phase systems are offered as standard products. See the previous pages for part numbers.

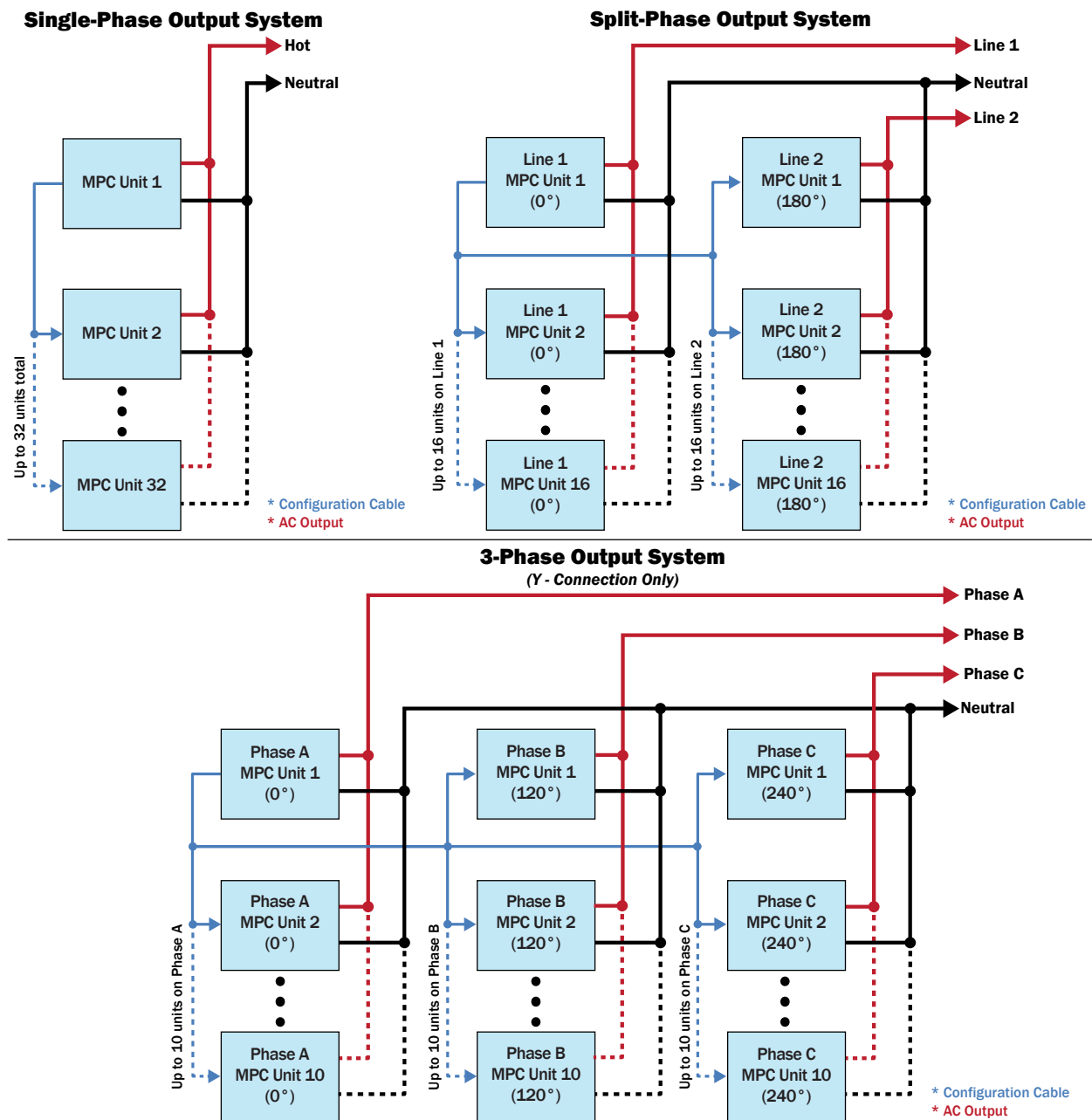

Parallel Connection of DC OUTPUTS

The DC1 outputs are not parallelable between multiple modules. A direct parallel connection of DC1 outputs from different modules will result in a circulating power between the two MPC devices. Diode-ORing devices added externally at the DC1 outputs will prevent any circulating power. However, the outputs will still not necessarily share the load current equally

DC2 outputs with the optional droop share feature are directly parallelable between multiple modules. Internal devices prevent circulating power between multiple units. The droop characteristic provides current sharing between parallel connected modules. Care should be taken to equalize the resistive drops between each unit and the load to maintain close matching of output current between multiple devices.

Connection of the AC and/or DC INPUTS

Whether there are two or three MPC units in the multiple-unit configuration, there are several ways that the AC and/or DC INPUTS can be connected to sources of power:

- They could be connected to the same AC and/or DC source, respectively.
- They could be connected to different AC and/or DC sources, respectively.

All that is necessary is to ensure that the input voltage falls within the specified range of the AC and/or DC INPUTS of the individual MPC units.

Furthermore, the individual AC and/or DC INPUT cables can be first combined into a single cable (of appropriate minimum wire size), or they can be left as separate cables, each connected to the desired AC or DC source.

Note that the MPC input circuit breaker disconnects the unit from the AC input bus should a MPC experience a hardware fault on its input stage. This, in conjunction with “R” option MPC units, allows for robust N+1 or N+M multi-unit systems.

3-Phase AC INPUT Source

When three MPC units are used (with their AC OUTPUTS connected either in parallel or in a 3-Phase configuration), each MPC unit’s AC INPUT can be connected to a different phase of a 3-Phase source. There are two different ways to do this:

- each MPC unit’s AC INPUT can be connected from a line (i.e., L1 or L2 or L3) of the AC source to the neutral wire of the AC source (assuming it is present), or
- each MPC unit’s AC INPUT can be connected from one line of the AC source to another (i.e., L1 to L2, L2 to L3, or L3 to L1)

Either connection scheme is acceptable, as long as the resultant input voltage falls within the specified range of the AC INPUT of the individual MPC units.

If the AC OUTPUTS of the three MPC units are connected in parallel, they will automatically share the total load power equally. Therefore, the power that they each draw from their respective AC INPUT phases will be balanced with each other. If, on the other hand, the three MPC units have their AC OUTPUTS connected in a manner to create a 3-Phase AC OUTPUT, then the power flowing through each MPC, and therefore the power drawn from each AC INPUT phase, will depend on the load power drawn from each AC OUTPUT phase. This load power may or may not be balanced.

Multi-unit AC Output On/Off Control – Standard Parallel (-F option)

In multi-unit operation, all combined front panel “on” switches must be actuated before any AC output will turn on. Any “off” front panel switch actuation will cause all AC outputs to turn off. In addition, the “remote-on” or “remote-off” rear panel signal inputs may be utilized for coordinated AC output on/off control. If any single MPC no longer has a valid input power source (e.g., no AC or DC input), the combined AC output will shutdown.

Multi-unit AC Output On/Off Control – Expanded Parallel (-R option)

For expanded parallel multi-unit operation, any “on” front panel switch actuation will cause all AC outputs to turn on at once. In addition, the “remote-on” rear panel signal can be used for a coordinated start.

Any “off” front panel switch actuation will cause that specific unit be deactivated. All other units will continue to function, assuming the load can be supported with one less unit. In addition, the “remote-on” or “remote-off” rear panel signal inputs may be utilized to enable and disable one specific unit.

For coordinated shutdown, the user must send “SYSTEM DISABLE” over RS-232. See Section VI of the Owner’s guide for details on the RS-232 interface. See MPC Terminal Commands document for more information on the “SYSTEM DISABLE” command.

AC Output Neutral Grounding

MPC units combined in multi-unit configurations must have the neutral floating “F” factory option to prevent the possibility of circulation protective earth currents. Expanded parallel units (“R” option) come with a floating neutral wire by default. If a grounded output neutral is required, then the output neutral should be connected to protective earth ground (PEGND) in one spot. The size of the neutral-to-PEGND connecting conductor must be sized to match the largest combined AC output neutral conductor specified in the wiring diagrams above.

Control Cable Connections

There are two high-density (three-row) DB15 connectors located on the rear panel of the MPC:

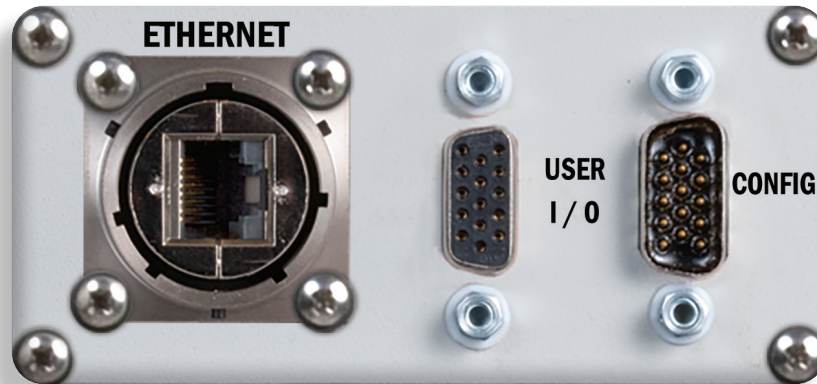

The User I/O female DB15 connector on the left is a connection to a host/system computer so that it can control the MPC and receive information regarding the status of the MPC.

The Configuration male DB15 connector on the right is for a connection between one SynQor MPC and another when, for instance, they have their outputs connected in parallel and they therefore need to communicate and coordinate with each other.

The designation/location of the pins for the User I/O female high-density DB15 connector is shown below:



Internal User I/O Circuits

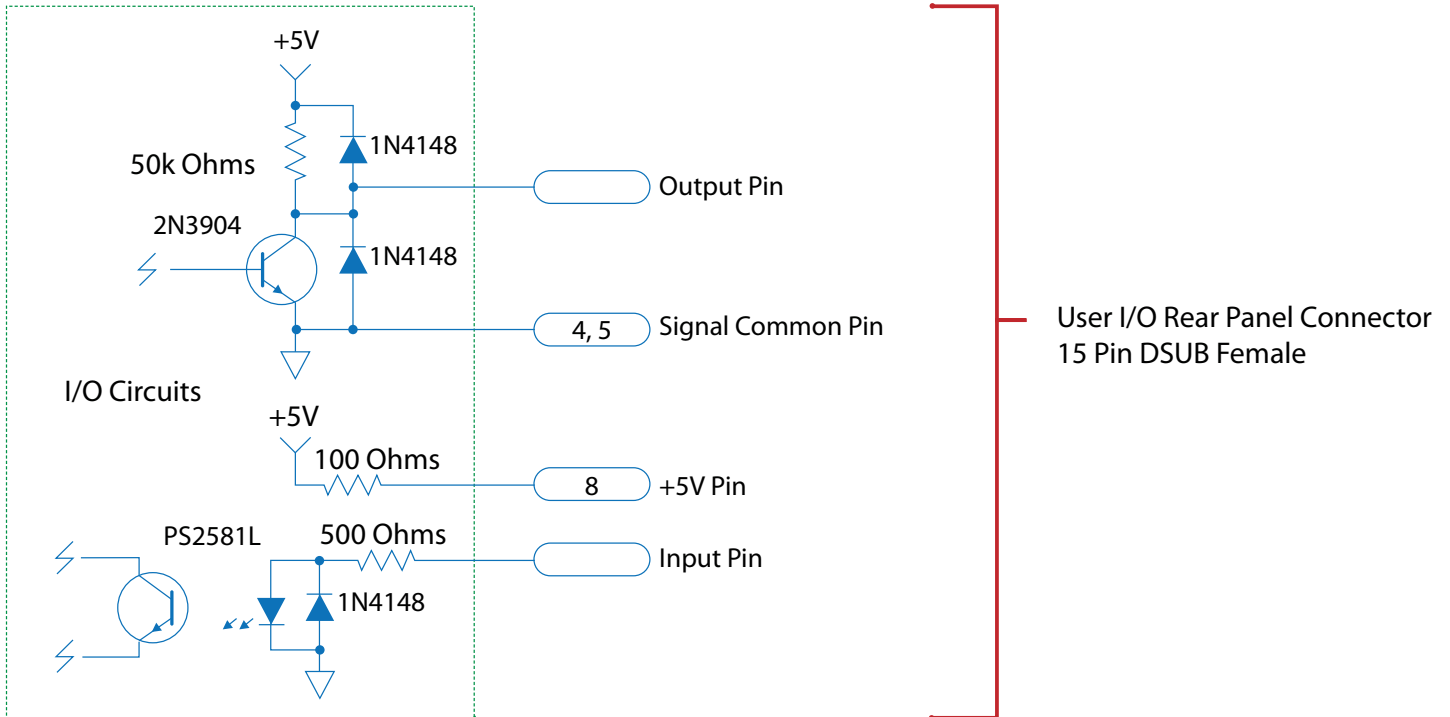

Remote On/Off Switch Connections

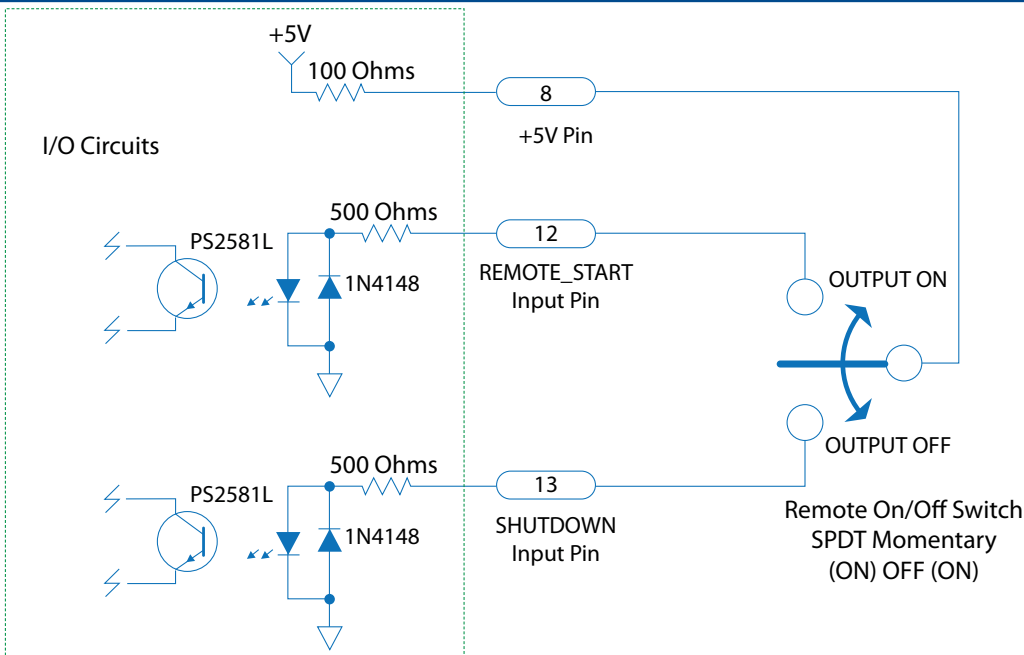

Note: A 2PDT or 3PDT switch may be substituted for single control of 2 or 3 MPC units, respectively.

Digital Input/Output Control Signals

There are 2 input and 5 output digital signals available on the User I/O female high-density DB15 connector. The pin assignments and functions of these digital I/O signals are as follows:

Signal	Pin Number	Function
+5 V	8	Bias voltage with minimal current drive usable as a pull-up voltage for the open collector output signals (100 Ω source resistance)
GND	4 and 5	Ground reference for all digital inputs and outputs
$\overline{\text{ACIN_GOOD}}$	7	Open collector* output where “low” indicates AC Input voltage is within range
$\overline{\text{OUT_OK}}$	14	Open collector* output where “low” indicates AC Output voltage is within range
$\overline{\text{OVER_TEMP}}$	15	Open collector* output where “low” indicates that the MPC is at or above its maximum temperature
REMOTE_START	12	Drive this line “high” with ≥ 5 mA to enable the MPC outputs
SHUTDOWN	13	Drive this line “high” with ≥ 5 mA to disable the MPC outputs

*with an internal 50 k Ω Pull-up Resistor to 5 V and ESD Protection Diodes.

RS232 Serial Interface

The same User I/O female high-density DB15 connector also provides for an RS232 interface between the MPC and the host/system computer. The interface has a 115.2 k baud with eight data bits, no parity bit and one stop bit. The pin assignments and functions for this RS232 interface are as follows:

Signal	Pin Number	Function
GND	4 and 5	Ground reference for RX and TX signals
RX	3	RS232 DCE/MPC Device Receive signal
TX	2	RS232 DCE/MPC Device Transmit signal

The RS232 port provides readback of MPC's state, as well as the configuration and control of the MPC's operation. The port can be used from a standard terminal interface, or from a custom computer application.

Readback information that is available:

- AC Input Voltage
- AC Input Current
- AC Input Frequency
- DC Input Voltage
- AC Output Voltage
- AC Output Current
- AC Output Power
- AC Output Frequency
- DC2 Output Voltage
- DC2 Output Temperature
- DC Output Power
- Total Output Power
- External Switch Input Status
- Fan RPM
- Internal Temperatures

Parameters that are controllable through the interface:

- Output enable / disable
- Fan diagnostics
- Alarm enable / disable

For a detailed description of the terminal interface see the SynQor website at:

http://www.synqor.com/UPS/documents/UPS_User_Commands.pdf

Ethernet Interface

The Ethernet interface provides a web page based user interface for monitoring and control of the MPC. The user can configure email alerts for MPC alarm conditions. The interface also exposes an SNMP interface compliant to RFC-1628.

The Ethernet interface supports 10BASE-T and 100BASE-T standards. It utilizes a standard RJ-45 connector, also allowing a metallic sealable circular military outer housing. The interface supports auto-negotiation, polarity correction, and Auto-MDIX (detection and use of straight through or cross-over cables).

IP address assignment can be done via DHCP or user entry of a static address. The interface also supports a direct connection between the MPC and a host computer by including a DHCP server internal to the MPC.

For a detailed description of the Ethernet port and SNMP implementation see the SynQor website at: http://www.synqor.com/ups/documents/UPS_Ethernet_SNMP_UG.pdf

Fans

The MPC-1500-1S “Shallow Rack” form factor has Field Replaceable fans that can be serviced by the user.

The MPC-1500-1U fans cannot be serviced by the user. The unit must be returned to the factory for repair should a fan fail.

Cleaning

The MPC-1500 unit has a sealed chamber for its electronics that is weather-proof. Only the fans on the rear panel are exposed to the environment, and these fans are also weather-proof. The unit can therefore be cleaned without concern of getting liquids inside the chamber. **NOTE**, however, that if the cables have been removed from the connectors the connectors should have their covers installed. If they are not, then care should be taken to not get excess liquid on the connector terminals. **ALSO NOTE** that care should be taken to not get excess liquid on the switch of the AC BREAKER on the back panel.

Cleaning should be done either with soap and water or with an Isopropyl alcohol and water mixture. A soft cloth should be used.

Do not immerse the unit in water to clean it.

Fault Conditions

With the exception of the Field Replaceable fans on the MPC-1500-1S, the MPC has no user-serviceable parts within it. If it has an internal malfunction only a factory trained personnel should attempt to repair it.

There are, however, several external conditions that could cause the MPC to not operate as desired. These external conditions can likely be corrected by the user.

The 10 LEDs on the front panel are the best and first place to look to determine what might be wrong with the MPC. The table on the next several pages is therefore organized by what these LEDs indicate, and for each indication there is a listing of what might possibly be wrong.

The front panel LED array is shown below. The designations of the 10 LEDs in this array are used in the following table.

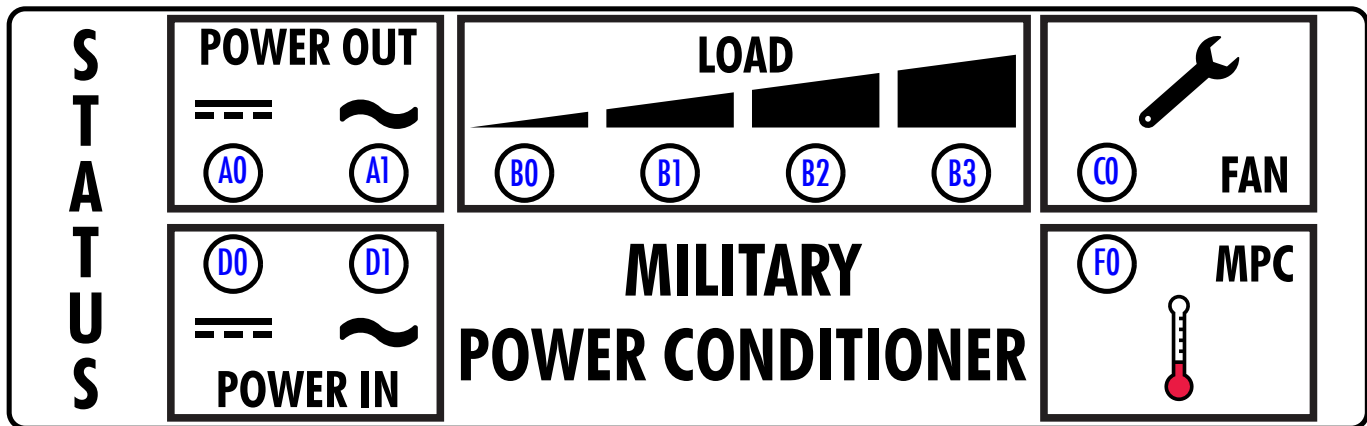

LED	Indication	Possible Problem(s)
D1: AC INPUT Power LED	LED is OFF	<ul style="list-style-type: none"> •The AC INPUT power source is not turned on. •The AC INPUT cable is not connected or it is wired wrong. •The AC Breaker on the rear panel is OFF. •The AC INPUT voltage is either too low or too high.
	LED is a STEADY GREEN and not a PULSING GREEN. MPC is instead running off the optional DC INPUT	<ul style="list-style-type: none"> •The AC INPUT voltage is within its proper range but the MPC is not selecting it for its source of power. •The AC INPUT voltage and the total load power may exceed the power derating curves given earlier in this Guide. •The AC INPUT cable may have too much series resistance. Thicker wire should be used.
D0: DC INPUT Power LED	LED is OFF	<ul style="list-style-type: none"> •The optional DC INPUT is not available on this unit. •The DC INPUT power source is not turned on. •The DC INPUT cable is not connected or it is wired wrong. •The DC INPUT cable is connected to the DC source with the wrong polarity. •The DC INPUT voltage is either too low or too high •The DC INPUT cable may have too much series resistance. Thicker wire should be used.
A1: AC OUTPUT Power LED	LED is OFF	<ul style="list-style-type: none"> •The MPC is OFF and needs to be turned ON.
	LED is AMBER	<ul style="list-style-type: none"> •The AC OUTPUT load is higher than 1250 W or 1500 VA by enough to trigger the power limit circuitry. •The AC OUTPUT load crest factor is too high. •The AC OUTPUT is shorted within the cable or a load. •Some other source of power is connected to the AC OUTPUT.
	LED is RED	<ul style="list-style-type: none"> •The MPC has been turned OFF, but due to a malfunction within the MPC it is still running and providing an AC OUTPUT voltage. •Some other source of voltage is connected to the AC OUTPUT and is powering it when the MPC is not.
A0: DC OUTPUT Power LED	LED is OFF	<ul style="list-style-type: none"> •The optional DC OUTPUT is not available on the unit. •The MPC is OFF and needs to be turned ON.
	LED is AMBER	<ul style="list-style-type: none"> •The DC OUTPUT load is higher than 1250 W (optional). •The DC OUTPUT is shorted within the cable or a load. •Some other source of power is connected to the DC OUTPUT.
	LED is RED	<ul style="list-style-type: none"> •The MPC has been turned OFF, but due to a malfunction within the MPC it is still running and providing an DC OUTPUT voltage. •Some other source of voltage is connected to the DC OUTPUT and is powering it when the MPC is not

LED	Indication	Possible Problem(s)
B0 – B3: LOAD POWER LEDs	B3 is BLINKING RED	<ul style="list-style-type: none"> •Total MPC load power is greater than or approaching 1250 W. The MPC may still be delivering its specified output voltage because the load power is not high enough to trigger the power limit circuitry.
	B0 – B3 are all OFF	<ul style="list-style-type: none"> •No power is being delivered to the load. •The MPC is OFF and needs to be turned ON. •The loads or output cables are not connected. •The loads are all turned off. •The loads are simply not drawing any appreciable power at the time.
F0: MPC Cooling System LED	LED is BLINKING GREEN	<ul style="list-style-type: none"> •Indicates that the fans are running at 67% of their rated speed. There is no problem.
	LED is AMBER	<ul style="list-style-type: none"> •Indicates that the fans are running at 100% of their rated speed. There is no problem, but the unit is operating at a high ambient temperature and a high load combination.
	LED is RED	<ul style="list-style-type: none"> •Fans are running at 110% of rated speed to keep the unit cool. The maximum recommended temperature may be exceeded, but the fans are keeping things cool enough to avoid triggering the over-temperature shut-down circuitry.
C0: Fan Service Required LED	LED is AMBER	<ul style="list-style-type: none"> •One or both fans have recently had degraded performance but seem to be ok now. The MPC is running a diagnostic test.
	LED is RED	<ul style="list-style-type: none"> •One or both fans presently have degraded performance, even if they are running, and service is recommended at the earliest convenient time. •Ensure that the fan blades are not obstructed from turning
Audible Alarm: (pattern repeats every 5 seconds)	Two tones	<ul style="list-style-type: none"> •The total MPC load power is above 1250 W. •Loads should be reduced if this condition persists.
	Three tones	<ul style="list-style-type: none"> •The AC OUTPUT has experienced either a short circuit or a load having a start-up surge current characteristic that the MPC could not start. The AC OUTPUT has therefore turned OFF. The DC output may still be powered. •To reset, the MPC must be turned OFF and then ON.

Two other conditions should be mentioned:

- The fans are off when the MPC is running

It is normal for the fans to be off, even if the MPC is running and delivering power to the load, as long as the temperature of the MPC is low enough. If the Fan Service Required LED (C0) is green, both of the fans are OK, even if they are not running.

- The MPC does not turn off when the ON/OFF switch is pushed down

When the ON/OFF switch on the front panel is pushed down, the MPC does not respond to this signal for approximately 1 second. This is done to ensure that the MPC is not accidentally turned off. If the user does not hold the ON/OFF switch in the OFF position for a full second before releasing it, the MPC will not turn off.

Other possible situations that are the result of external issues that a user could likely correct are related to:

- Loads that draw a large surge of current at start-up

Some AC loads draw a very large amount of current when an input voltage is first applied to them. This might happen when the MPC is first turned on if the load is already connected to the MPC. Or it may happen when the load itself is turned on and/or connected to the AC OUTPUT of a MPC that is already running. Common examples of such loads are motors and incandescent lights, but some electronic equipment can also display this characteristic.

Several problems could arise with such a load:

- The MPC fails to start the load:

The SynQor MPC is designed to try various start-up routines when it is first turned on to overcome the problem of surge currents with some loads. There are five such routines (or repetitions of a given routine) that are tried. If the load is not started after these five routines are attempted, the MPC will turn OFF. To get the MPC to try again, the user should again push the ON/OFF switch on the front panel to the ON position.

If the MPC cannot start the load, then it may be possible that a custom start-up routine could be devised to work with this particular load. Contact the factory for more information.

If there is more than one load of the AC OUTPUT that displays this start-up surge characteristic, and the MPC is not capable of starting with all of them connected and switched on, it may be possible to switch on each load in turn. For instance, if the MPC cannot start up with a load consisting of a large bank of incandescent lights, then it may be able to start if various sections of the lights are switched on in sequence.

- A newly started load disturbs the existing MPC loads.

A common problem can occur when the MPC is running and powering one or more loads connected to its AC OUTPUT, and then an additional load of the AC OUTPUT is turned on. If this newly started load draws a large surge current at start-up, it can cause the current limit of the MPC's AC OUTPUT to be triggered, and the AC OUTPUT voltage will then drop. This drop could cause the existing loads to be disturbed. Furthermore, if the voltage drops far enough, the MPC will turn off its AC OUTPUT and initiate a new start-up sequence (after 0.1 seconds). This latter action would cause the power flow to the existing loads to be interrupted.

If this disruption of existing loads is a problem, then the solution is to make sure the loads that display this start-up surge characteristic are all started first, or that all loads are started at the same time.

- Cable wire resistance is too high:

As mentioned in the section "Power Cables Wire Size", the resistance of a power cable's wires gives a voltage drop from the upstream to the downstream end of the cable. This voltage drop, if large enough, will cause the either MPC to determine that the voltage at its AC INPUT or its DC INPUT is below its minimum specified value, even though the corresponding voltage at the source of AC or DC power is within the specified range.

This problem is particularly possible for the DC INPUT, since the DC INPUT current is so high (as much as 65 A at full power) and the DC INPUT voltage is so low (as low as 22 V).

The phenomenon that may be displayed is the following.

- Assume the AC INPUT source is not present, but the DC INPUT source is.
- The MPC, before it turns on, does not draw any power or current from the DC INPUT, and therefore the voltage drop across the DC INPUT cable is zero.
- The MPC sees that the voltage at the DC INPUT is within its specified range, and enables its outputs.
- As the load then draws power, the MPC begins to draw current from the DC INPUT cable. This current causes a voltage drop to appear across the cable.
- If the voltage at the DC source is close to, but still above, its 22 V minimum, but the voltage drop across the cable is large enough for the voltage at the DC INPUT of the MPC to fall below 22 V, then the MPC will determine that the DC INPUT is out of range and will shut down.
- Since the MPC no longer draws current from the DC INPUT, the voltage drop across the DC INPUT cable goes back to zero volts.

- After a while, the MPC decides the DC INPUT voltage is back within its proper range, and begins to draw a current from the DC INPUT.
- The cycle above repeats itself for a total of three times, at which point the MPC stops trying to draw power from the DC INPUT for one minute. After this one minute another set of 3 cycles are repeated, followed by another stop for one minute, and so on.

This same problem can also occur for the AC INPUT if the voltage at the AC source is close to the specified 80 Vrms minimum limit. In this case the MPC will try ten times before stopping for a one minute interval.

The solution to this problem is to make sure that the cable has wires of sufficient diameter, or “gauge” for the length of the cable. The longer the cable, the bigger diameter the wire should have.

See the section “Power Cable Wire Size” for recommended cable wire sizes.



MPC **MILITARY FIELD-GRADE**

MILITARY POWER CONDITIONER

Operator's Guide *MPC-1500 Series*



Made in USA

006-0006452

03/03/2021

REV P

SynQor[®]
Advancing The Power Curve[®]